



master flex

- KT - 6012 MASTERflex Single Copper
- KT - 6022 MASTERflex Dual Copper
- KT - 6013 Masterflex Single Fiber
- KT - 6023 Masterflex Dual Fiber

kvm-tec MANUAL

COMPATIBILITY

kvm-tec Extender Compatibility



	ECOSmart	Easyline	FlexLine	media4Kconnect	media4Kconnect SPECIAL	media4Kconnect 12G SDI	Scalableline	Matrixline UltraLine	Gateway	Gateway2GO
point to point	✓	✓	✓	✓	✓	✓		✓ ✓	✓	✓
Matrix Switching Systems without Management	✓ up to 76 endpoints									
Matrix Switching Systems Full HD with Switching Manager	✓ up to 2000 endpoints		✓ up to 100 endpoints; Switches & MatrixKey					✓ up to 2000 endpoints; Switches		
Matrix Switching Systems 4K/8K				✓	✓	✓	✓	✓ up to 2000 endpoints; Switches		
Matrix Switching Systems 1080p (Full HD & 4K)	✓		✓	✓	✓	✓				
Hybridline Commander Systems (Data Scalable, Scalableline Full HD)			✓ Switches, Dual Local				✓			
Hybridline Commander Systems (Data Scalable, Scalableline 4K)							✓ Scalableline, Local & Remote			
all Hybridline Commander systems & Gateways								✓ ✓		

KVM-TEC	IHSE GmbH	IHSE USA LLC	IHSE GMBH Asia	IHSE China Co.,Ltd
Gewerbepark Mitterfeld 1 A 2523 Tattendorf Austria	Benzstr.1 88094 Oberteuringen Germany	1 Corp.Dr.Suite Cranbury NJ 08512 USA	158Kallang Way,#07-13A 349245 Singapore	Room 814 Building 3, Kezhu Road Guangzhou PRC
www.kvm-tec.com	www.ihse.com	www.ihseusa.com	www.ihse.com	www.ihse.com.cn

TABLE OF CONTENT

1. Introduction	8
1.1 Intended use	8
1.2 Safety instructions	9
1.3 Technical Specifications	11
1.4 About your MASTERflex single copper	12
1.5 About your MASTERflex dual copper	14
1.6 About your MASTERflex extender dual in fiber	16
1.7 Product elements - MASTERflex extender single in fiber	18
1.8 Product elements - MASTERflex extender dual fiber	20
1.9 About your MASTERflex backpanel	22
1.10 About the status LED	23
2. Installation of the Extender	24
2.1 Unpacking and checking the contents	24
2.2. Mounting options	26
2.2.1 Mounting pads and rubber feet	26
2.2.2 Mounting kits (optional)	26
2.3 Installing the extender	27
2.4 Quickinstallation MASTERflex single copper	28
2.5 Quickinstallation MASTERflex dual in copper	29
2.6 Quickinstallation MASTERflex single in fiber	30
2.7 Quickinstallation MASTERflex dual in fiber	31

TABLE OF CONTENT

2.8 Start up	32
2.9 Replacing the SFP module	32
2.10 Removing a CATx cable	33
2.11 Removing a fiber cable	33
2.12 Best practice for Windows 10	34
3. Extender settings	37
3.1 Using the on screen menu	37
3.2 System Status	38
3.3 Viewing the current firmware version	39
3.4 Features Menu	39
3.4.1 Point to Point	40
3.4.2 Matrix Switching Mode	40
3.4.3 USB Save Feature	40
3.4.4 Display the last received image „Freeze Last Image“	41
3.4.5 USB Emulation Mode	42
3.4.6 Power redundance Alert and Link redundance Alert	42
3.4.7 Diagnosis Menu	43
3.5 DDC Menu	45
3.5.1 DDC Main (single)	46
3.5.2 DDC Second (dual)	47
3.6 Extender Settings	48

TABLE OF CONTENT

3.6.1 Local Settings	49
3.6.2 USB Compatibility mode	50
3.6.3. USB Remote wake up	51
3.6.4 Compatibility with Linux	52
3.6.5 Bandwidth reduction	52
3.6.6 VGA Parameters	53
3.7 Remote Settings	54
3.7.1 Editing a keyboard layout	55
3.7.2 Editing keyboard shortcuts	56
3.7.3 Setting the audio volume	57
3.7.4 USB share any key	58
3.7.5 Using the power saving mode	59
3.7.6 Hiding System status menu	60
3.7.7 Change keyboard fallback modus	61
3.7.8 Lock menu	62
3.7.9 Mouse speed	63
3.7.10 Monitor sync strength	63
3.8 Update	65
3.8.1 Firmware update with Switching Manager	65
3.8.2 Firmware update with USB stick	66
3.9 Unlock an upgrade	67
3.9.1 Enable or Disable USB Memory upgrade	69

TABLE OF CONTENT

3.9.2 Enable or Disable Sound upgrade	69
3.9.3 Enable or Disable VGA upgrade	69
3.10 About this device	70
4. Network Settings	71
4.1 Display Switching list	72
4.2 PUSH / GET List	73
4.3 Favorite List	74
4.4 Connecting, disconnecting or selecting a current workplace connected devices	75
4.5 Searchbox-function	76
4.6 IP Management	77
5. Troubleshooting & First Aid	80
6. Maintenance & Care	82
6.1 Extender care	82
6.2. Disposal	82
7. Warranty	83
7.1. Standard warranty	83
7.2 Extended warranty	83
8. Cable requirements	84
8.1 Requirements for CAT5e/6/7 cables	84
8.2 Requirements fiber cables	85

TABLE OF CONTENT

8.2.1 Multi-Mode (standard)	85
8.2.2 Single-Mode (optional)	85
9. Requirements network- switch	86
9.1 Recommended Switches	86
10. Address & phone / emails	87
11. Notes	88

1. INTRODUCTION

Congratulations on the purchase of your new MASTERflex MV/MV-F KVM Extender. You have bought a high quality extender. These instructions are part of this product. They contain important information regarding safety, use and disposal for every user of the MASTERflex MV and MV-F KVM Extender. Please familiarise yourself with the information within prior to using your product. Use the product only in the manner as described and for the areas of application as stated. When passing the product to a third party be sure to also supply all instructions and other relevant documentation. Following proper use and maintenance, your MASTERflex MV/MV-F KVM Extender will bring you joy for many years to come.

1.1 INTENDED USE

This product is intended to be used as a device to increase the distance that a keyboard, monitor and mouse can be placed from a computer. This product is intended for professional use. The product should not be used in potentially explosive environments.

The product may only be used according to the instructions as described in this manual. All use, other than that described in this manual, is seen as unintended use. Modifications in the course of technological progress are reserved. In these user instructions the MASTERflex MV/MV-F KVM Extender is referred to as 'product' or 'extender'. The MV/PC is referred to as the 'local unit' (CPU) and the MV/Monitor is referred to as the 'remote unit' (CON).

1. INTRODUCTION

1.2 SAFETY INSTRUCTIONS

WARNING! Read and understand all safety instructions.



- Follow all the instructions. This will avoid accidents, fire, explosions, electric shocks or other hazards that may result in damage to property and/or severe or fatal injuries. Please ensure that everyone who uses the product has read and followed these warnings and instructions.
- Keep all safety information and instructions for future reference and pass them on to subsequent users of the product.
- The manufacturer is not liable for cases of material damage or personal injury caused by incorrect handling or non-compliance with the safety instructions. In such cases, the warranty will be voided.
- This product is not intended for use by persons (including children) with restricted physical, sensory or intellectual capability or lack of experience and/or knowledge, unless they are supervised by a person who is responsible for their safety or provides them with instructions on how to use the product.

DANGER! Not for use in potentially explosive environments.



DANGER! Be vigilant at all times, and always take care around this product. Do not use electrical equipment if you are lacking in concentration or awareness, or are under the influence of drugs, alcohol or medication. Even a moment of inattentiveness can lead to serious accidents and injuries when using electrical equipment. Check the product and the cables for any damage before use. If there is any visible damage, a strong odour, or excessive overheating of components unplug all the connections immediately and stop using the product.



DANGER! The MV-F KVM Extender is a Class 1 Laser Product 1 according to DIN 40008/EN and VDE 0837.

If the product is not installed and used in accordance with this manual, it may cause disruptive interference with radio or television reception or affect other electronic products in residential areas.

- Use shielded cables only to connect the components in order to avoid such interference. Non-compliance invalidates the permission to operate this product.
- Only the mains adapter included with the product should be used as the power supply. Do not use other adapters.
- Prior to connecting to the mains, make sure your local mains voltage matches the rating indicated on the product.
- The product must be connected to a permanent and earthed AC wall socket.

1. INTRODUCTION

- Protect cables from being strained, pinched or buckled and place them in a way to prevent people from tripping over the cord.
- In particular, ensure to avoid damage to the mains adapter.
- Use the product with a suitable, properly installed and easily accessible mains power socket. Make sure the product can be disconnected from the power socket at all times.
- Unplug the product during electrical storms or when not in use.

DANGER! Never touch the adapter with wet hands.



Use the product within the specified performance limits.

Keep the product away from flammable materials such as curtains and drapes.

Protect the mains adapter from use by third parties (particularly children). Keep the unused mains adapter in a dry, elevated or locked location away from children.

- Do not place the product near heaters.
- Do not drop or hit the product.
- Unplug all connections before cleaning the product. Do not use wipes or chemicals as these could damage the surface. Wipe the housing with a damp cloth. Electrical/ electronic parts must not be cleaned.
- Alterations to the product and technical modifications are not permitted.

1. INTRODUCTION

1.3 TECHNICAL SPECIFICATIONS

Type:	KVM Extender (local unit and remote unit)
Model:	MASTERflex single and dual copper MASTERflex single and dual fiber
Power supply input voltage:	100 - 240 V; 50/60 Hz AC
Power supply output:	12V; 1A (external power supply)
Power requirement:	12W VDC1A redundant pro Extender (without connected USB devices)
Operating temperature range:	0 °C to 45 °C / 32 °F to 113 °F
Storage temperature range:	-25 °C to 80 °C / -13 °F to 176 °F
Relative humidity:	max. 80% (non-condensing)
Storage humidity:	max. 80% (non-condensing)
Casing Material:	Anodized aluminium
Dimensions:	approx. 97,5 x 41 x 103,5 mm / 3.83x 1.57 x 4.7 inch
Weight:	local unit 302g/0.66lbs. remote unit 291g/0.64lbs
Expected product life:	82 820 hours / 9.5 years

1. INTRODUCTION

1.4 ABOUT YOUR MASTERFLEX SINGLE COPPER

Local Extender (CPU)

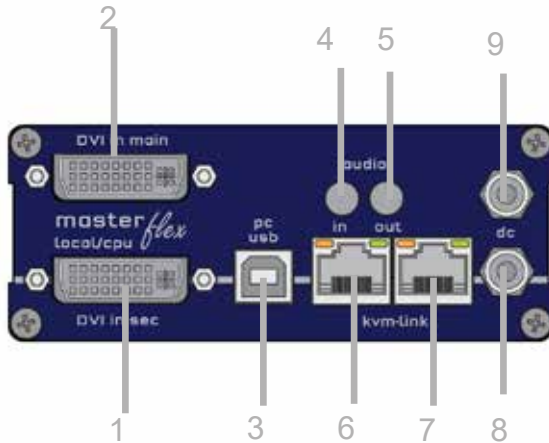

No.	Name	Function
1	dvi-in	DVI connection to PC
2	dvi-in	DVI connection from PC
3	USB	USB to PC
4	audio in	Audio in from PC
5	audio out	Audio out to PC
6	kvm-link	Network cable redundant
7	kvm-link	Network cable
8	dc	connection for 12V1A power supply redundant
9	dc	connection 12V2A power supply

LED STATUS

yellow	LINK ok
green	Video ok
green blinking	Video and USB activity

1. INTRODUCTION

Remote Extender (CON)

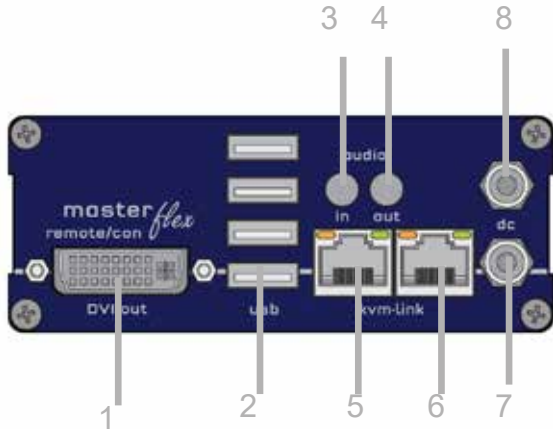

No.	Name	Function
1	DVI out	DVi to monitor .
2	USB	USB from keyboard and mause
3	audio in	Audio in from microfon etc.
4	audio out	Audio to loudspeaker
5	kvm-link	connection for 12 V network cable
6	kvm-link	connection for CAT5/6/7 cable redundant
7	dc	connection power supply 12V1A redundant
8	dc	connection power supply 12 V2A

LED STATUS

yellow	LINK ok
green	Video ok
green blinking	Video and USB activity

1. INTRODUCTION

1.5 ABOUT YOUR MASTERFLEX DUAL COPPER

Local Extender (CPU)

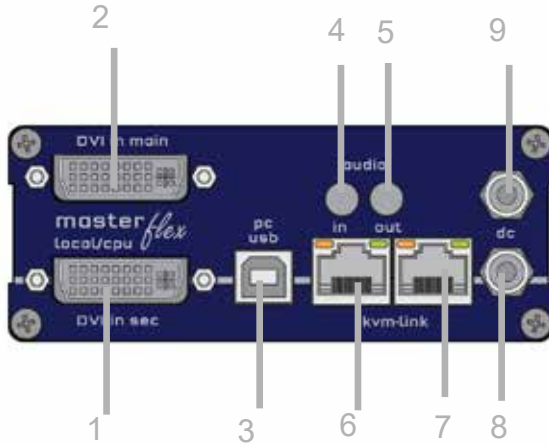

No.	Name	Function
1	dvi-in	DVI in 2 from PC
2	dvi-main	DVI connection to PC
3	USB	USB to PC
4	audio in	Audio Out from PC
5	audio out	Audio Out to PC
6	kvm-link	connection network cable
7	kvm-link	connection network cable
8	dc	connection 12V1A power supply
9	dc	connection 12V1A power supply

LED STATUS

yellow	LINK ok
green	Video ok
green blinking	Video and USB activity

1. INTRODUCTION

Remote Extender (CON)

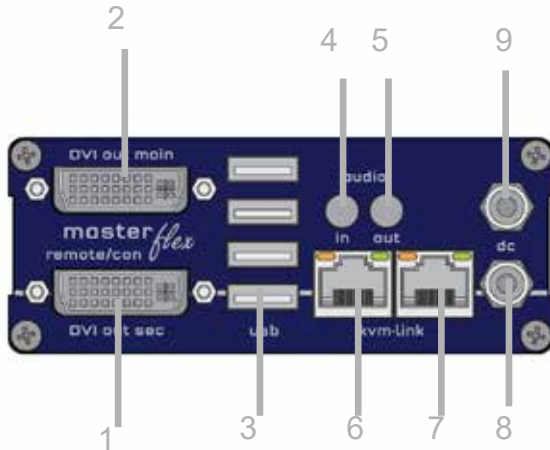

No.	Name	Function
1	DVI	DVI to Monitor 2
2	DVI	DVI to Monitor 1
3	USB	USB from Keyboard and mouse
4	audio in	Audio in from Microphone.
5	audio out	Audio to loudspeakers
6	kvm-link	connection for 12 V network cable
7	kvm-link	connection for CAT5/6/7 cable
8	dc	connection power supply 12V1A
9	dc	connection power supply 12V1A

LED STATUS

yellow	LINK ok
green	Video ok
green blinking	Video and USB activity

1. INTRODUCTION

1.6 ABOUT YOUR MASTERFLEX EXTENDER DUAL IN FIBER

Local Extender (CPU)

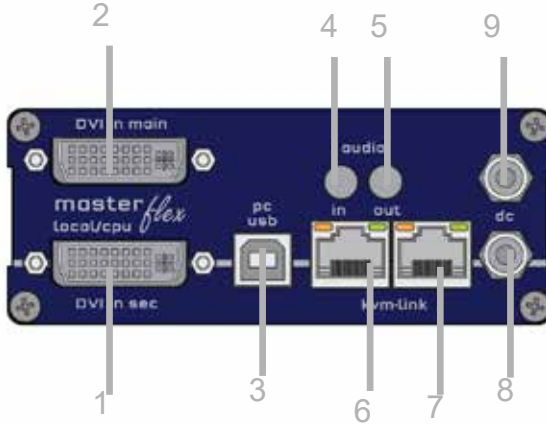

No. Name

1	dvi-in	DVI in 2 from PC
2	dvi-main	DVI connection from PC
3	USB	USB to PC
4	audio in	Audio Out from PC
5	audio out	Audio Out to PC
6	kvm-link	connection Fibercable redundant
7	kvm-link	connection for fibercable
8	dc	connection 12V1A power supply redundant
9	dc	connection 12V1A power supply

LED STATUS

yellow	LINK ok
green	Video ok
green blinking	Video and USB activity

1. INTRODUCTION

Remote Extender (CON)

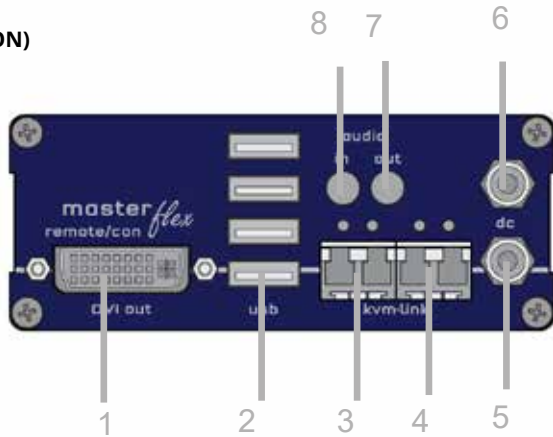

No.	Name	Function
1	DVI out	DVI to Monitor .
2	USB	USB from keyboard and mouse
3	kvm-link	connection for fibercable redundant
4	kvm-link	connection for fibercable
5	dc	connection power supply 1212A redudant
6	dc	connection power supply 12V1A
7	audio out	Audio to loudspeaker
8	audio in	Audio in from microphone etc .

LED STATUS

yellow	LINK ok
green	Video ok
green blinking	Video and USB activity

1. INTRODUCTION

1.7 PRODUCT ELEMENTS - MASTERFLEX EXTENDER SINGLE IN FIBER

Local Extender (CPU)

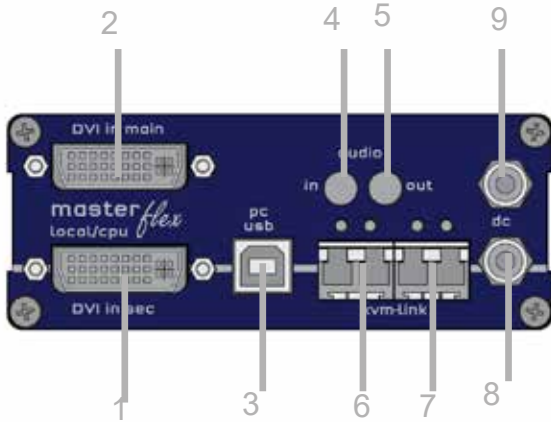

No	Name	Function
1	dvi-out	DVI connection to monitor
2	dvi-in	DVI in from PC
3	USB	USB to PC
4	audio in	Audio in from PC
5	audio out	Audio out to PC
6	kvm-link	connection fiber cable redundant
7	kvm-link	connection fibercable
8	dc	connection power supply 12V1A redundant
9	dc	conenction power supply

LED STATUS

yellow	LINK ok
green	Video ok
green blinking	Video and USB activity

1. INTRODUCTION

Remote Extender (CON)

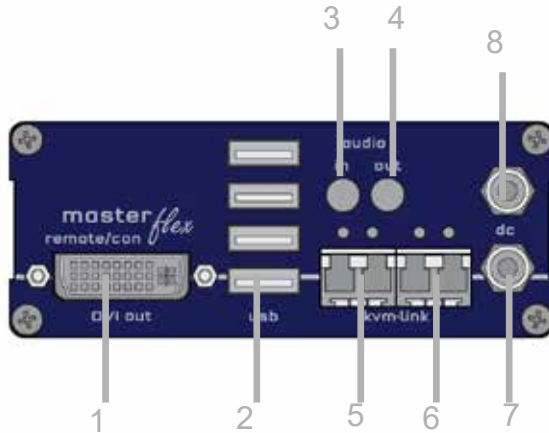

No.	Name	Function
1	DVI-out	DVI to Monitor.
2	USB	USB from keyboard and mouse
3	audio in	Audio in from microphone
4	audio out	Audio out to loudspeaker
5	kvm-link	connection fiber cable
6	kvm-link	connection fiber cable redundant
7	dc	connection 12V1A power supply redundant
8	dc	connection power supply

LED STATUS

yellow	LINK ok
green	Video ok
green blinking	Video and USB activity

1. INTRODUCTION

1.8 PRODUCT ELEMENTS - MASTERFLEX EXTENDER DUAL FIBER

Local Extender (CPU)

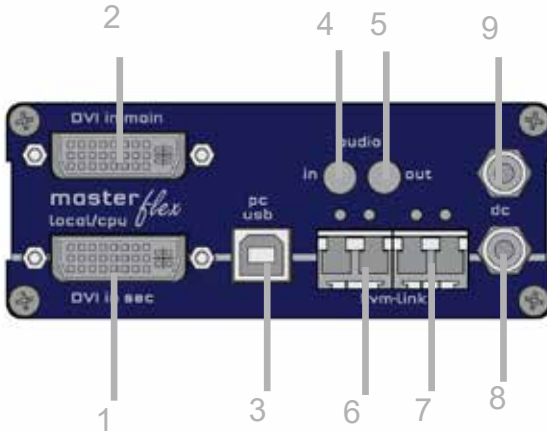

No.	Name	Function
1	dvi-in	DVI 2 connection from PC
2	dvi-main	DVI to PC
3	USB	USB from PC
4	audio in	Audio from PC
5	audio out	Audio to PC
6	kvm-link	connection networkcable redundant
7	kvm-link	connection networkcable
8	dc	connection power supply 12V1A redundant
9	dc	connection power supply 12V1A

LED STATUS

yellow	LINK ok
green	Video ok
green blinking	Video and USB activity

1. INTRODUCTION

Remote Extender (CON)

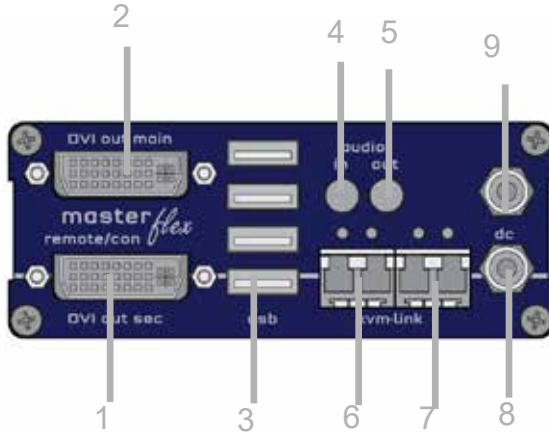

No.	Name	Function
1	dvi out	DVI to Monitor 2
2	dvi out	DVI to Monitor 1
3	USB	USB from keyboard and mouse .
4	audio in	Audio in from microphone
5	audio out	Audio out to loudspeaker
6	kvm-link	connection for fibercable
7	kvm-link	connection fibercable redundant
8	dc	connection power supply 12V1A redundant
9	dc	connection power supply 12V1A

LED STATUS

yellow	LINK ok
green	Video ok
green blinking	Video and USB activity

1. INTRODUCTION

1.9 ABOUT YOUR MASTERFLEX BACKPANEL

BACKSIDE SMARTflex Single & SMARTflex Dual



No.	Name	Function
1	LED Status	display LED Status
2	Reset	Button for Reset



1. INTRODUCTION

1.10 ABOUT THE STATUS LED





The Status LED (8/15) can light red, orange or green. Table 1 shows the meaning of each colour. Also see chapter *Troubleshooting*.

1.5 ABOUT THE STATUS LED

LED Status Update:

Farbe	Anzeige des Lichtes	Autoupdate Modus
	fast flashing	Update runs
	shining	Update failed
	shining	Update successful

Meaning LED displays

Farbe	Anzeige des Lichtes	Bedeutung
	shining	only network connection available
	fast flashing	No active connection
	shining	No video signal
	shining	everything works

A detailed error description can be found in chapter [First Aid](#)

2. INSTALLATION OF THE EXTENDER

2.1 UNPACKING AND CHECKING THE CONTENTS

Before using the product for the first time it should be checked for damage. In case of damage due to transport inform the carrier immediately. Before delivery the product is checked for its function and its operating safety.



- Make sure that the packaging contains the following content:

MASTERflex single copper delivery content - Local (CPU)

- 1 x MV1 local (CPU)
- 1 x wall power supply 12V 1A (EU-plug or int plug)
- 1 x DVI - DVI cable 1,8m/5.9 ft)
- 1 x USB cable 1,8m/ 5.9 ft
- 1 x VGA - DVI cable 1,8m / 5.9 ft (opt)
- 2 x Audio cable 1,8m/5.9ft (opt)

delivery content - Remote (CON)

- 1 x MV1 remote (CON)
- 1 x wall power supply 12V 1A (EU-plug or int plug)
- 4 x rubber feet

MASTERflex dual copper delivery content - Local (CPU)

- 1 x MV2 local (CPU)
- 1 x wall power supply 12V 1A (EU-plug or int plug)
- 2 x DVI - DVI cable 1,8m/5.9ft
- 1 x USB cable 1,8m/5.9ft
- 2 x VGA - DVI cable 1,8m/5.9 ft (opt)
- 2 x Audio cable 1,8m/5.9ft (opt)

delivery content - Remote (CON)

- 1 x MV2 remote (CON)
- 1 x wall power supply 12V 1A (EU-plug or int plug)
- 4 x rubber feet

2. INSTALLATION OF THE EXTENDER

Make sure that the packaging contains the following content:

MASTERflex single fiber

Delivery content - Local (CPU)

- 1 x MV1-F local (CPU)
- 1 x wall power supply 12V 1A (EU-plug or Int plug)
- 1 x DVI - DVI cable 1,8m/5.9ft
- 1 x USB cable 1,8m/5.9ft
- 1 x VGA - DVI cable 1,8m/5.9ft (opt)
- 2 x Audio cable 1,8m/5.9 ft (opt)
- 2x SFP Module-Multimode up to 500m/1640 ft duplex LC
alternativ with Single-Mode up to 20km/12mi /ItemNr 6835
- 4 x rubber feet

Delivery content- Remote (CON)

- 1 x MV1-F Remote (CON)
- 1 x wall power supply 12V 1A (EU-plug or INT plug)
- 2 x SFP Module Multimode up to 500m/1640 ft duplex LC
Alternativ with Single-Mode up tp 20km/12mi ItemNr 6835
- 4 x rubber feet

MASTERflex dual fiber

Delivery content- Local (CPU)

- 1 x MV2-F local (CPU)
- 1 x wall power supply 12V 1A (EU-plug or INT plug)
- 2 x DVI - DVI cable 1,8m/5.9ft
- 1 x USB cable 1,8m/5.9 ft
- 2 x VGA - DVI cable 1,8m/5.9ft
- 2 x Audio cable 1,8m/5.9ft (opt)
- 2 x SFP Module-Multimode up to 500m/1640ft
(alternativ Single-Mode up to 20km/12mi ItemNr 6835)
- 4 x rubber feet

Delivery content Remote (CON)

- 1 x MV2 remote (CON)
- 1 x wall power supply 12V 1A (EU-plug or INT plug)
- 4 x rubber feet

2. INSTALLATION OF THE EXTENDER

2.2. MOUNTING OPTIONS

2.2.1 MOUNTING PADS AND RUBBER FEET

The mounting pads and rubber feet can be used to hold the extenders in place and prevents them from sliding and falling.

To attach the mounting pads or rubber feet:

1. Remove the protection layer from the **mounting pads** or **rubber feet** (G).
2. Attach the **mounting pads** or **rubber feet** (G) to the bottom the units.

2.2.2 MOUNTING KITS (OPTIONAL)

The following mounting kits are available:

Rack mounting kit RMK-FLEX-F *Part Nr. KT - 6232 RMK-FLEX-F*

The rack mounting kit RMK-F is for mounting kvm-tec MASTERflex extenders. It consists of a 19" rack shelf and an alu-faceplate. 4 single or 4 dual Extender

Rack mounting kit RMK- FLEX- FN - T *Part-Nr. KT - 6233 RMK- FLEX-FN*

The rack mounting kit RMK-FN is for assembling kvm-tec MASTERflex extenders. - 4 single or 4 dual Extender. It consists of 19" Rack Shelf, an alu-faceplate and a power supply.

Under Desk Mounting kit *Part Nr KT - 6231 UMK-FLEX*

The Under Desk Mounting kit is for underdesk mounting of the MASTERflex extender.

Din Rail Mounting *Part-Nr. KT - 6235 DINMK-FLEX*

The DIN rail mounting is used for space-saving installation in control cabinets or on DIN rails. The attachment to the MASTERflex extenders is possible in several ways.

Vesa Mounting *Part-Nr.KT - 6236 VH-FLEX*

The robust VESA mounting is used to attach an extender to a monitor with existing VESA mounting points. The Extender becomes one unit with the monitor and saves a lot of space and cable clutter. The VESA mounting kit can be combined with an existing monitor mounting.

2. INSTALLATION OF THE EXTENDER

2.3 INSTALLING THE EXTENDER

WARNING! Read and understand all safety information before installing the product.



The units can be set up to access one host computer, or to access numerous host computers. In the case of the latter, an additional Network Switch must be installed. With a Network Switch, each user can gain quick access to any of the required computers.

point to point connection & Matrix Switching System

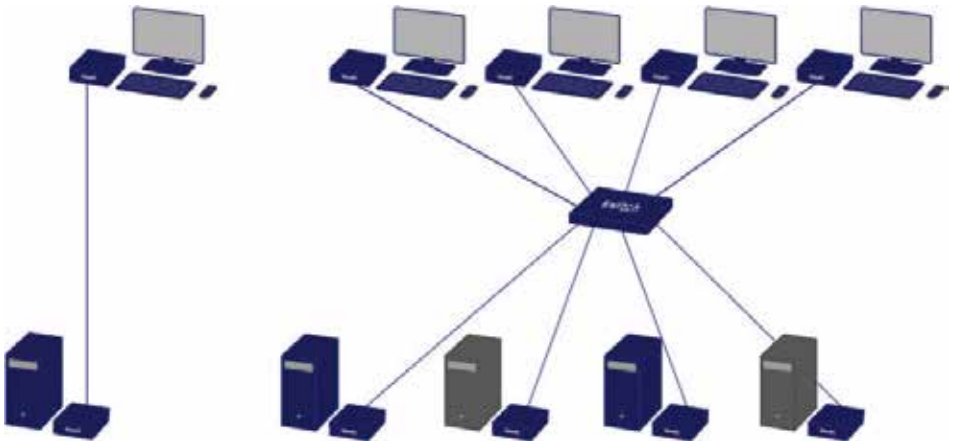

2. INSTALLATION OF THE EXTENDER

2.4 QUICKINSTALLATION MASTERFLEX SINGLE COPPER

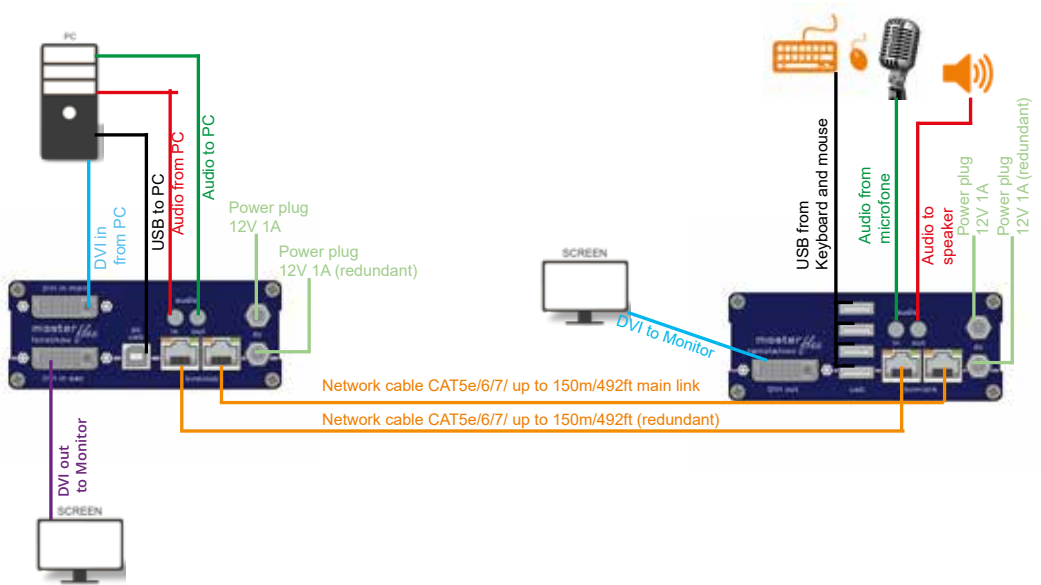

1. Connect the CON / Remote and the CPU / Local Unit to the included 12V 2A power supply.
2. Now connect the USB cable to a USB port on your PC and connect the other end of the USB cable to the CPU / Local Unit. Connect keyboard and mouse to the CON / Remote Unit.
3. Connect the CPU / Local and the CON / Remote Unit with a network cable.
4. Now connect the DVI cable to the DVI socket of the PC and the other end to the DVI socket of the CPU Local Unit (PC-in).
5. Opt: Connect PC audio/out with the audio cable to local audio/in. Connect audio/out via the audio cable
6. Almost done! Opt: Connect the audio cable local audio/out to the PC audio/in and remote audio/out with audio cable to the microphone
7. Using a switch: Connect all endpoints to the switch. Ensure that all connections have a bandwidth of 1Gbit/sec. For video sharing the network has to support IGMP snooping.

2. INSTALLATION OF THE EXTENDER

2.5 QUICKINSTALLATION MASTERFLEX DUAL IN COPPER

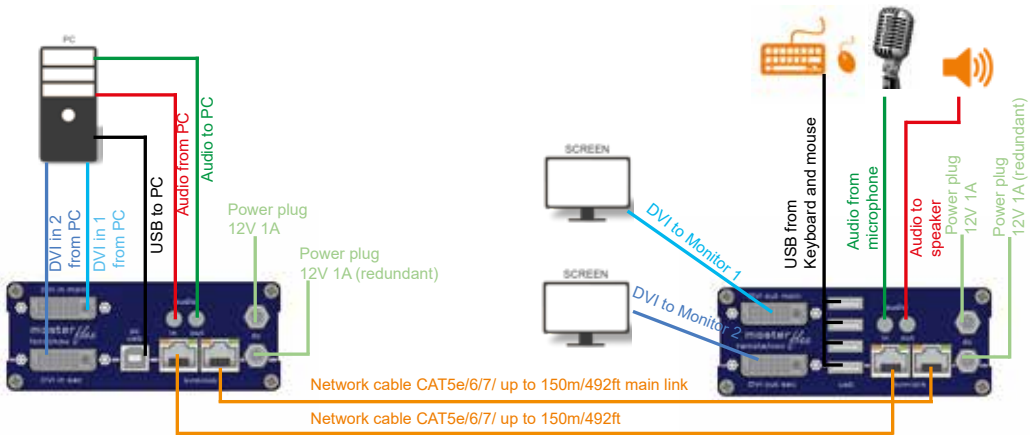

1. Connect the CON / Remote and the CPU / Local Unit to the included 12V 2A power supply.
2. Now connect the USB cable to a USB port on your PC and connect the other end of the USB cable to the CPU / Local Unit. Connect keyboard and mouse to the CON / Remote Unit.
3. Connect the CPU / Local and the CON / Remote Unit with a network cable.
4. Now connect the DVI cable to the DVI socket of the PC and the other end to the DVI socket of the CPU / Local Unit (PC-in).
5. Connect the DVI cable to the DVI socket of the PC and the other end to the DVI socket of the CON / Local Unit (PC-in 2). Then connect the monitor to the CON / Remote Unit using the DVI cable.
6. Opt: Connect PC Audio out with the audio cable to local audio/in. Connect audio/out via the audio cable
7. Almost done! Opt: Connect the audio cable local audio/out to the PC audio/in and remote audio/out with audio cable to the microphone
8. Using a switch: Connect all endpoints to the switch. Ensure that all connections have a bandwidth of 1Gbit/sec. For video sharing the network has to support IGMP snooping.

2. INSTALLATION OF THE EXTENDER

2.6 QUICKINSTALLATION MASTERFLEX SINGLE IN FIBER

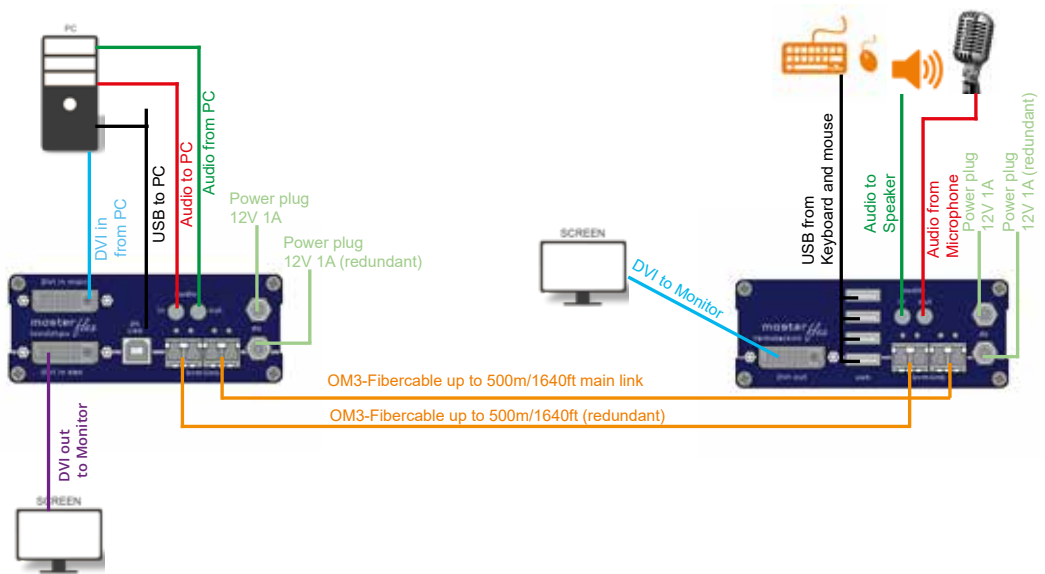

1. Connect the CON / Remote and the CPU / Local Unit to the included 12V 2A power supply.
2. Now connect the USB cable to a USB port on your PC and connect the other end of the USB cable to the CPU / Local Unit. Connect keyboard and mouse to the CON / Remote Unit.
3. Connect the CPU / Local and the CON / Remote Unit with a network cable.
4. Now connect the DVI cable to the DVI socket of the PC and the other end to the DVI socket of the CPU / Local Unit (PC-in).
5. Then connect the monitor with the DVI cable to the CON / Remote Unit.
6. Opt: Connect PC audio/out with the audio cable to local audio/in. Connect audio/out via the audio cable
7. Almost done! Opt: Connect the audio cable local audio/out to the PC audio/in and remote audio/out with audio cable to the microphone
8. Using a switch: Connect all endpoints to the switch. Ensure that all connections have a bandwidth of 1Gbit/sec. For video sharing the network has to support IGMP snooping.
9. Almost done! Connect the audio cable Local audio/out to the PC audio/in and Remote audio/out with the audio cable to the microphone

2. INSTALLATION OF THE EXTENDER

2.7 QUICKINSTALLATION MASTERFLEX DUAL IN FIBER

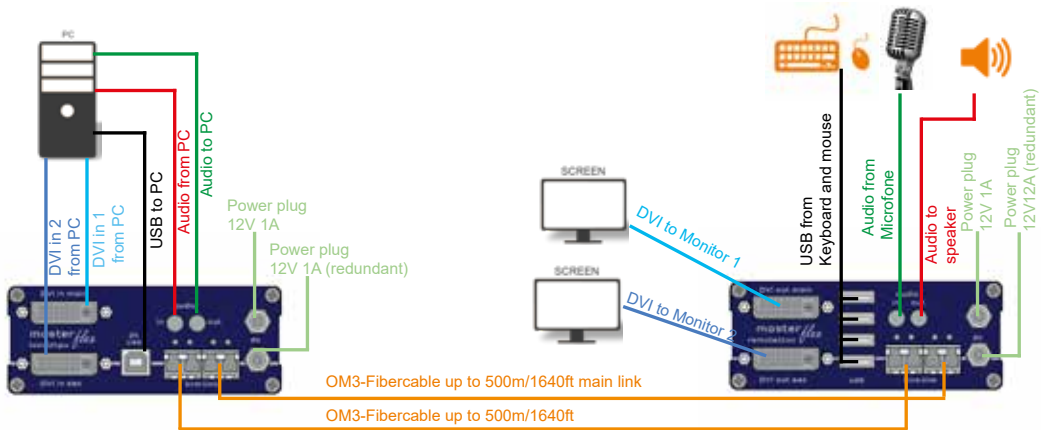

1. Connect the CON / Remote and the CPU / Local Unit to the included 12V 2A power supply.
2. Now connect the USB cable to a USB port on your PC and connect the other end of the USB cable to the CPU / Local Unit. Connect keyboard and mouse to the CON / Remote Unit.
3. Connect the CPU / Local and the CON / Remote Unit with a network cable.
4. Now connect the DVI cable to the DVI socket of the PC and the other end to the DVI socket of the CPU / Local Unit (PC-in).
5. Now connect the DVI cable to the DVI socket of the PC and the other end to the DVI socket of the CPU / Local Unit (PC-in 2). Then connect the monitor with the DVI cable to the CON / Remote Unit.
6. Connect PC audio/out with the audio cable to local audio/in. Connect audio/out via the audio cable
7. Almost done! Connect the audio cable local audio/out to the PC audio/in and remote audio/out with audio cable to the microphone
8. Using a switch: Connect all endpoints to the switch. Ensure that all connections have a bandwidth of 1Gbit/sec. For video sharing the network has to support IGMP snooping.

2. INSTALLATION OF THE EXTENDER

2.8 START UP

To start up the system without switch:

1. Make sure that the two monitors and the computer are switched on.
2. If you are using a Network Switch, connect the power supply to an earthed wall socket.
3. Connect both extender **power supplies (C)** to an earthed wall socket. Both extenders will start an initialisation process. The red status LED blinks a few seconds. After a few seconds the status LED lights green. The monitor will display your computer's desktop or any open applications.

2.9 REPLACING THE SFP MODULE

The MV1-F is delivered with a multimode SFP module.

To replace an SFP module with a different SFP module:

1. Remove the black dust protector from the SFP module.
2. Pull the metal latch of the SFP module forwards until it is at a right angle.
3. Replace the SFP module with the other module. Put the metal latch back in position. Only use SFP modules from kvm-tec, or recommended by kvm-tec.

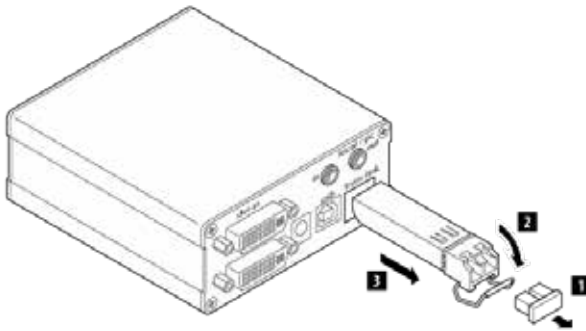

2. INSTALLATION OF THE EXTENDER

2.10 REMOVING A CATX CABLE

To remove a CATx cable:

- Press the latch down and slowly pull the cable out.

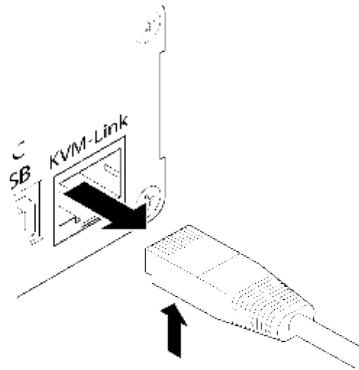

2.11 REMOVING A FIBER CABLE

To remove a fiber cable:

- Press the latch down and slowly pull the cable out.

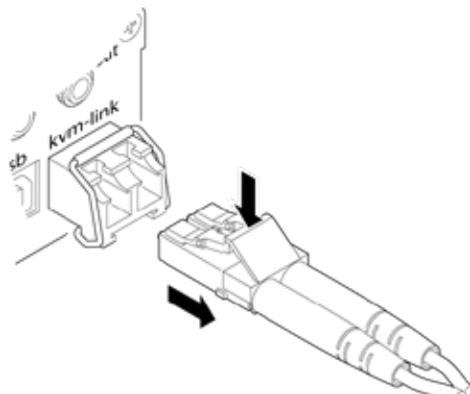

2. INSTALLATION OF THE EXTENDER

2.12 BEST PRACTICE FOR WINDOWS 10

Disable USB Energy Savings in Windows 10

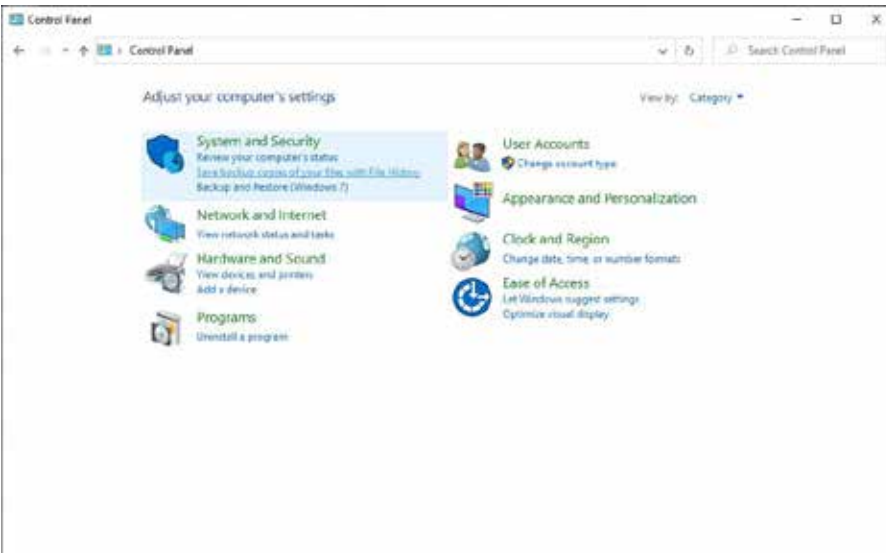
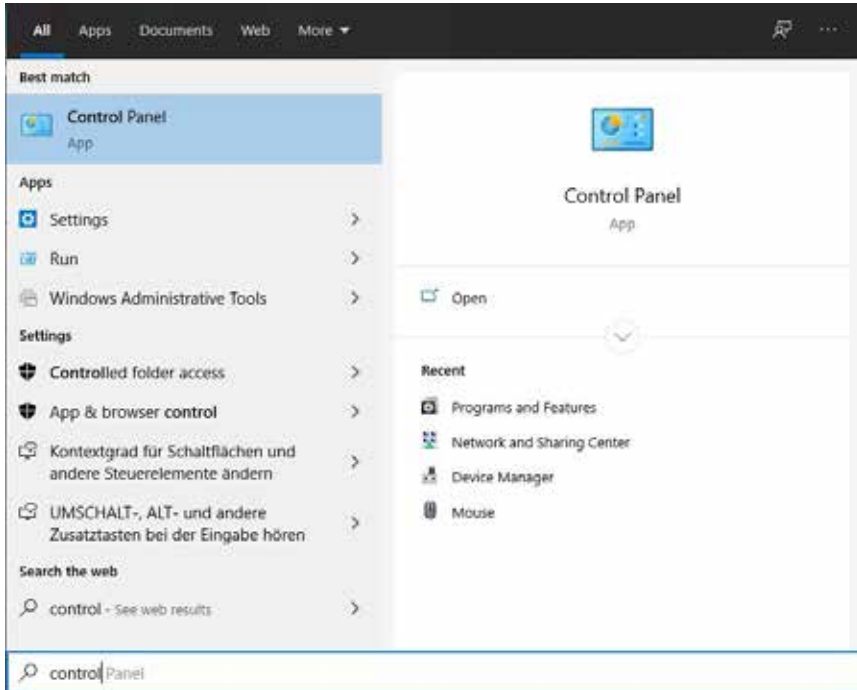

2. INSTALLATION OF THE EXTENDER

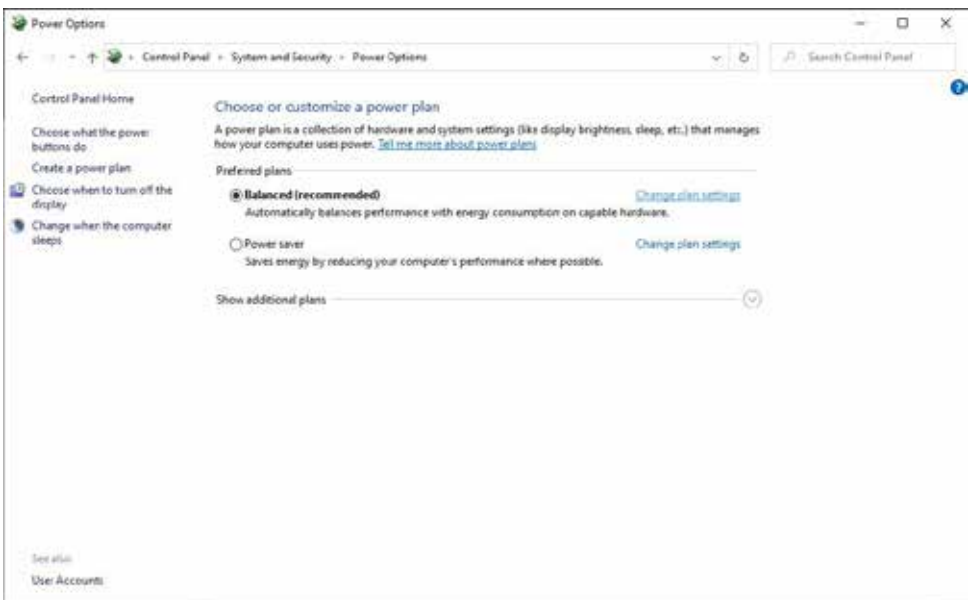
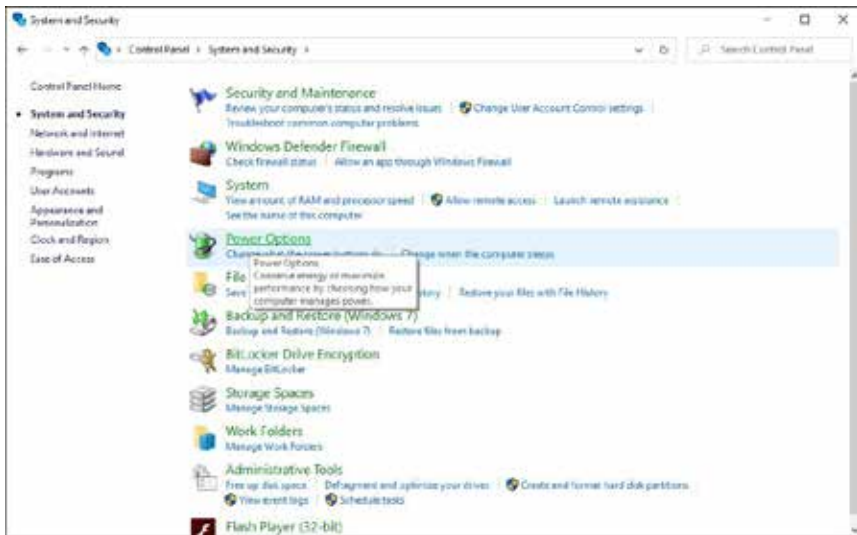

2. INSTALLATION OF THE EXTENDER

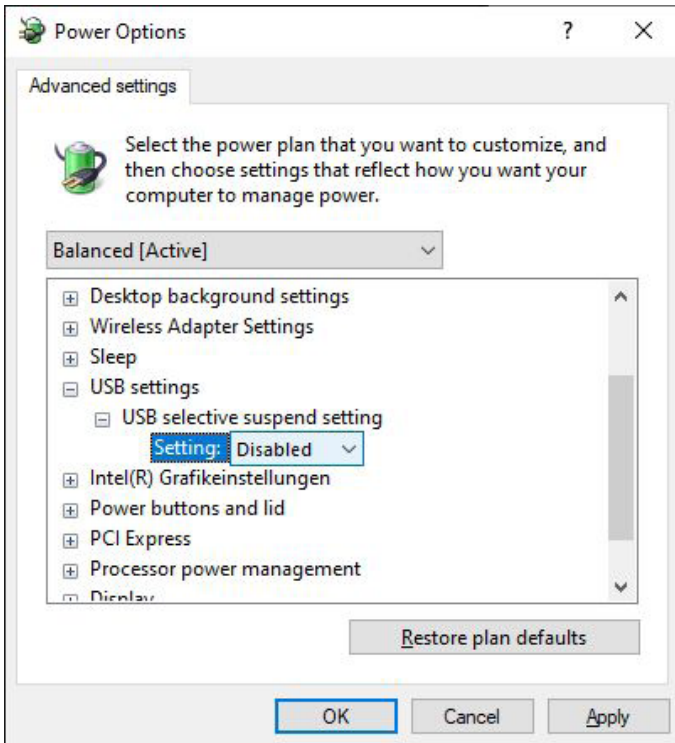
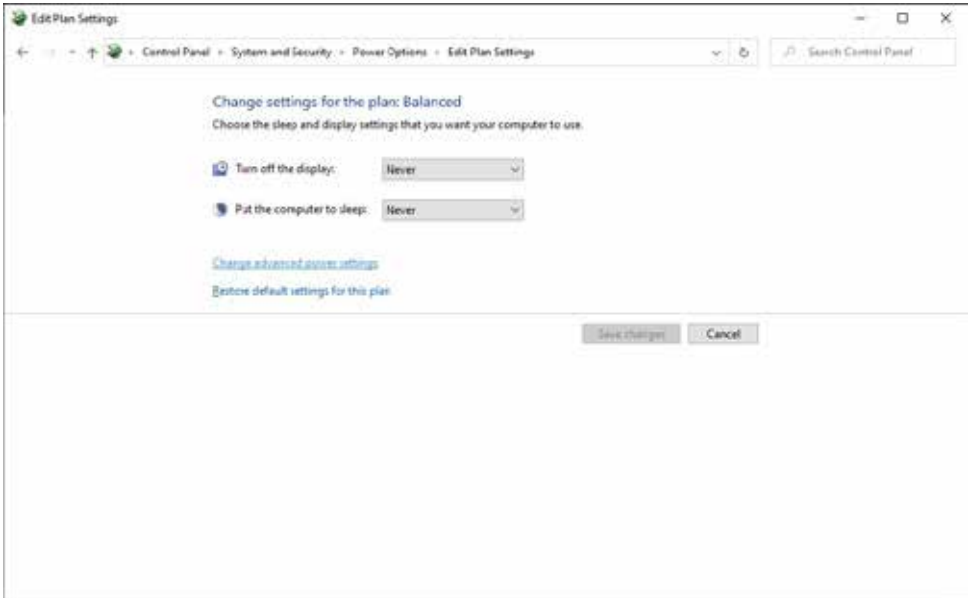

3. EXTENDER SETTINGS

3.1 ACCESS TO THE MAIN MENU

Use the monitor and keyboard to access the main menu

Access to the main menu (main menu):

1. Make sure the extenders, monitors and computers are turned on.
2. Press the Alt Gr key five times quickly. The **main menu** and an overview of the an overview of the submenus is displayed.
3. To enter a submenu, press the corresponding key.

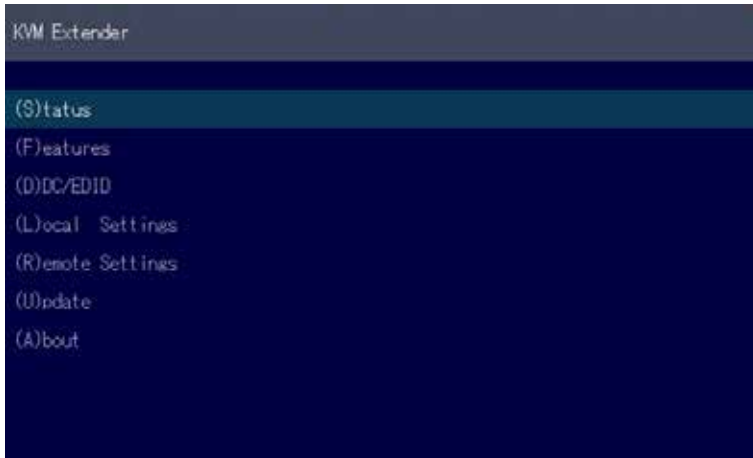

Main Menu

Main menu Short Cuts :

S	Status Overview	Status menu / current status
F	Features Overview	Features settings
D	DDC Option	DDC Option Fixed Setting 1020 x 1080
L	Local Settings	Settings Local
R	Remote Setting	Settings Remote
U	Update Flash FW	Update firmware
A	About Overview	Upgrade overview
L	Link redundancy	for single units
Q	Exit	Finish

3. EXTENDER SETTINGS

3.2 SYSTEM STATUS



Single

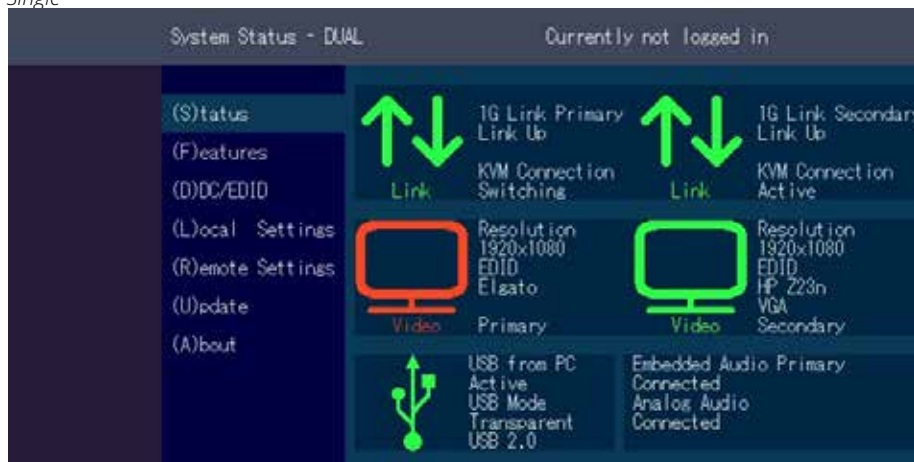

Dual

In the status overview menu the current status of the extender connection is displayed. It provides information on the connection itself as well as resolution of the video channel, and USB-status.

The enabled options and the current firmware-version is displayed in the left top corner. Link status shows whether there is a physical connection available. **Connected** indicates if kvm data is currently able to be transmitted.

Video and USB show if data is currently being transmitted.

3. EXTENDER SETTINGS

3.2 FIRMWARE VERSION DISPLAY

Make sure that the main menu is open. Under „A“ - About the currently installed firmware version of the remote (CON) and local (CPU) extender is displayed (e.g. ,4267’).

3.3 FEATURES MENU

Press the F key to enter the Features menu.

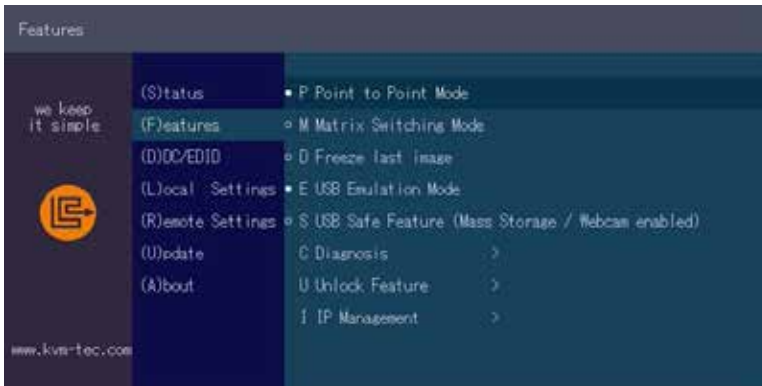

Features Menu

P	Point to Point Mode	Enabled/Disabled (Point to Point excludes itself with Matrix mode)
M	Matrix Switching Mode	Disabled/Enabled
D	Freeze last Image	(Disabled)Disabled/Enabled
E	USB Emulation Mode	(Disabled) Disabled/Enabled
S	USB Save Feature	(mass storage usable) Disabled/Enabled
C	Diagnosis	Diagnostic menu
U	Unlock Features	Activate features
I	IP Management	IP Management
L	Link redundancy	for single units

3. EXTENDER SETTINGS

3.4.1 POINT TO POINT

You can switch the Point to Point mode on and off by pressing the „P“ key



ATTENTION - if the Point to Point mode is activated, the switching mode cannot be activated

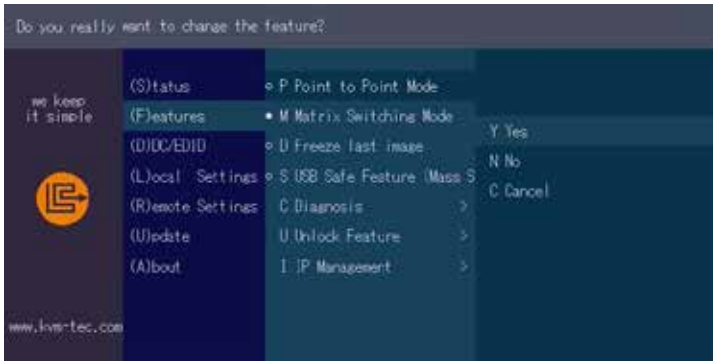

3.4.2 MATRIX SWITCHING MODE

By pressing the „M“ button you can switch the Matrix Switching Mode off and on

3.4.3 USB SAVE FEATURE

The kvm-tec feature „USB save“ prevents the intrusion of viruses via the USB interface by deactivating mass storage devices.

By pressing the key „S“ you can switch the USB save feature on and off

3. EXTENDER SETTINGS

3.4.4 DISPLAY THE LAST RECEIVED IMAGE „FREEZE LAST IMAGE“

With the „freeze last image“ function, the last image received can be displayed instead of a black screen when the remote extender (CON) is disconnected from the local extender (CPU). To show that it is the last image received, the frame of the image will blink red.

To enable or disable the „freeze last image“ function: 1. from the Extender Settings menu,

press the **F** button. The Features Settings menu is displayed.

Press the **D** button to enable or disable the function.

Press **ESC** to return to the main menu.

Press **I** to enable or disable the function.

Press **ESC** to return to the main menu

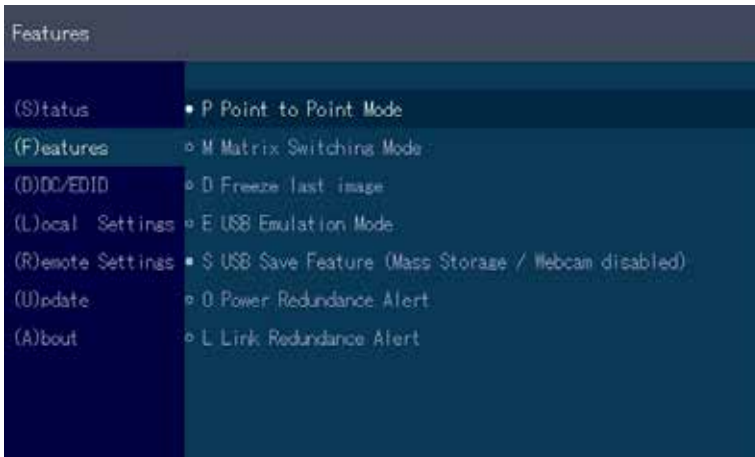

3. EXTENDER SETTINGS

3.4.5 USB EMULATION MODE

When this mode is set, the local extender emulates a keyboard and mouse always connected to the PC. The result is switching from one PC to another PC without any switching delay. Emulation Mode is restricted to mouse and keyboard only.

3.4.6 POWER REDUNDANCE ALERT AND LINK REDUNDANCE ALERT

Our Masterflex and Maxflex single devices are redundant. Should one port fail, the other port immediately takes over. In such a case you will receive an alarm and can see which port has failed.

Power Redundance Alert (Only for devices with two DC sockets):

„SEC POWER LOST“ / „PRIM POWER LOST“

Link Redundance Alert (Only for single devices with two RJ45 jacks):

„PRIM LINK LOST“ / „SEC LINK LOST“ / „BOTH LINK LOST“

Oder

„SEC LINK ERROR“ with active redundancy

„PRIM LINK ERROR“ with active redundancy.

Features	
(S)tatus	◦ P Point to Point Mode
(F)eatures	• M Matrix Switching Mode
(D)C/EDID	• D Freeze last image
(L)ocal Settings	◦ E USB Emulation Mode
(R)emote Settings	• S USB Save Feature (Mass Storage / Webcam disabled)
(U)pdate	◦ O Power Redundance Alert
(A)bout	• L Link Redundance Alert

REDUNDANCE: SEC POWER LOST!
REDUNDANCE: SEC LINK ERROR!

3. EXTENDER SETTINGS

3.4.7 DIAGNOSIS MENU

In the Diagnosis menu, the runtimes of the individual connected channels are displayed. Both Remote Unit and Partner Local Unit are listed.

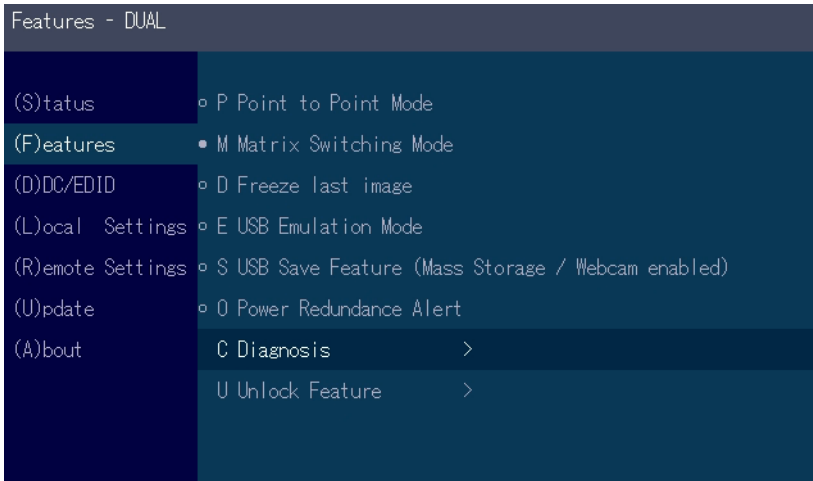

Additionally you get the CPU temperature information of both units. Another feature is the cable test

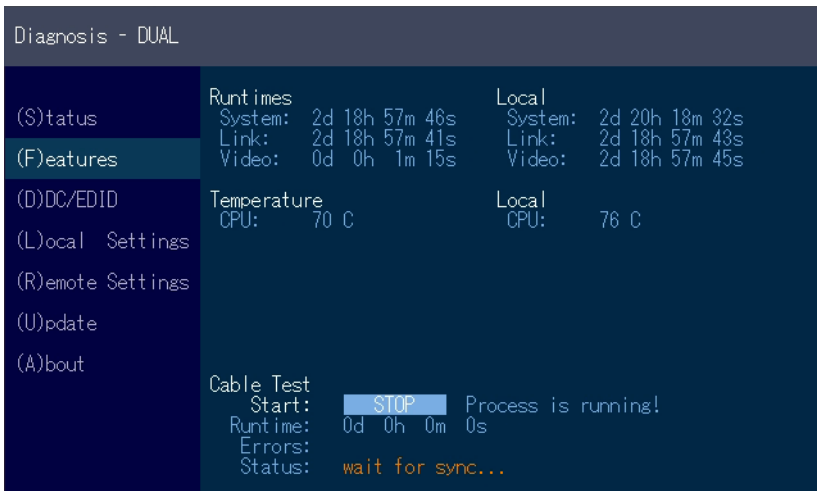

3. EXTENDER SETTINGS

As soon as a connection to the partner has been established, the test can be started with the „Enter“ key or the arrow key on the right „→“.

After a valid synchronization process, the test is started and the test run time and errors are displayed.

```
Diagnosis - DUAL

(S)tatus          Runtimes          Local
                  System: 2d 18h 57m 53s  System: 2d 20h 18m 38s
                  Link: 2d 18h 57m 48s   Link: 2d 18h 57m 50s
(F)eatures        Video: 0d 0h 1m 22s    Video: 2d 18h 57m 52s

(D)C/EDID        Temperature       Local
                  CPU: 70 C           CPU: 76 C

(L)ocal Settings

(R)emote Settings

(U)pdate

(A)bout

Cable Test
Start: [STOP] Process is running!
Runtime: 0d 0h 0m 7s
Errors: 0
Status: Check Errors...
```

The test can be ended at any time by pressing the “Enter” or “→” key. If no error has occurred, the status reports: “Test OK! If errors occurred during the test, the status displays the sum of all errors that occurred.

```
Diagnosis - DUAL

(S)tatus          Runtimes          Local
                  System: 2d 18h 57m 56s  System: 2d 20h 18m 42s
                  Link: 2d 18h 57m 51s  Link: 2d 18h 57m 53s
(F)eatures        Video: 0d 0h 1m 25s    Video: 2d 18h 57m 55s

(D)C/EDID        Temperature       Local
                  CPU: 70 C           CPU: 76 C

(L)ocal Settings

(R)emote Settings

(U)pdate

(A)bout

Cable Test
Start: [RUN] (Press Enter or Right-Key)
Runtime: 0d 0h 0m 0s
Errors:
Status: Test OK!
```

3. EXTENDER SETTINGS

3.5 DDC MENU

The DDC Information menu allows the user to specify which DDC information is used by the PC.

Definition of the DDC information used by the PC:

1. make sure that the main menu is open.

Press the O button and the DDC option menu will be displayed.

- Press 0 to display the DDC information of the monitor connected to the remote (CON) Extender is connected.

- Press 2 to save the current DDC information. The system will apply the same settings after restarting the Extender

- Press the keys 4 to 8 to use a predefined resolution, which is saved.

3. press ESC to return to the main menu

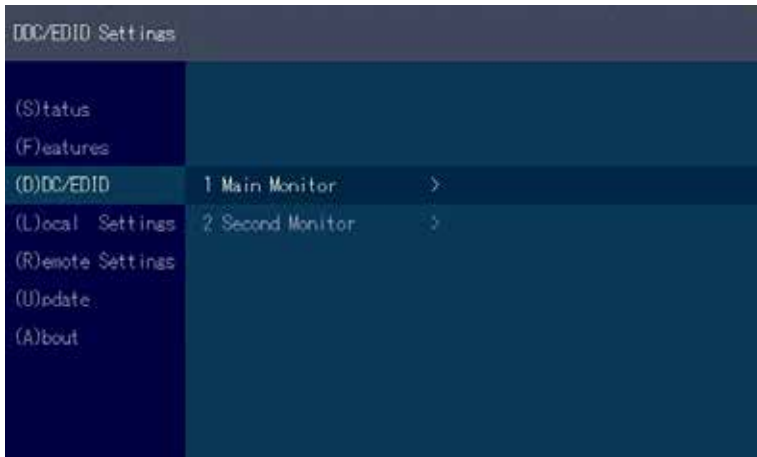

3. EXTENDER SETTINGS

3.5.1 DDC MAIN (SINGLE)

DDC/EDID Settings Main		
(S)tatus		Current Setting: Remote Main
(F)eatures		1 Remote Main
(D)DC/EDID	1 Main Monitor >	2 Set current DDC as fixed
(L)ocal Settings	2 Second Monitor >	3 FIX 640 × 480
(R)emote Settings		4 FIX 1024 × 768
(U)pdate		5 FIX 1280 × 1024
(A)bout		6 FIX 1680 × 1050
		7 FIX 1920 × 1080
		8 FIX 1920 × 1200

3. EXTENDER SETTINGS

3.5.2 DDC SECOND (DUAL)

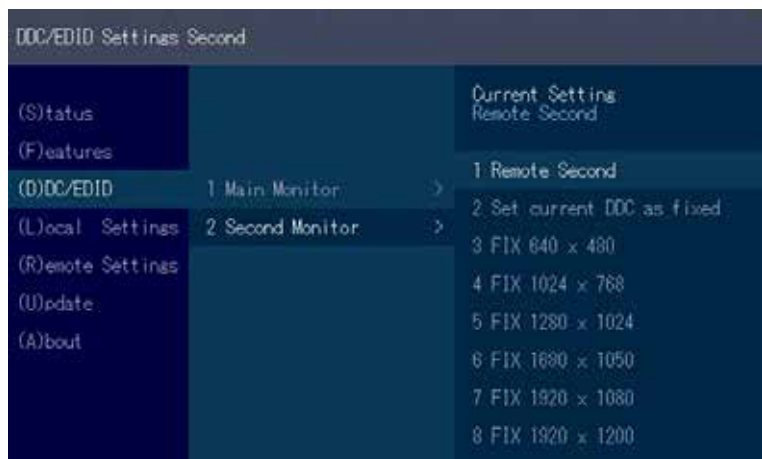

3. EXTENDER SETTINGS

3.6 EXTENDER SETTINGS

The Extender Settings menu allows the user to change a number of other settings. Select one of the three options (VGA, Audio and RS232) to enter the submenu. The other four can be activated or deactivated by pressing the corresponding button.

Display the Extender Settings menu:

1. Make sure that the main menu is open.
2. Press the L button. The Local Settings menu is displayed.
3. Press the R button. The Remote Settings menu is displayed

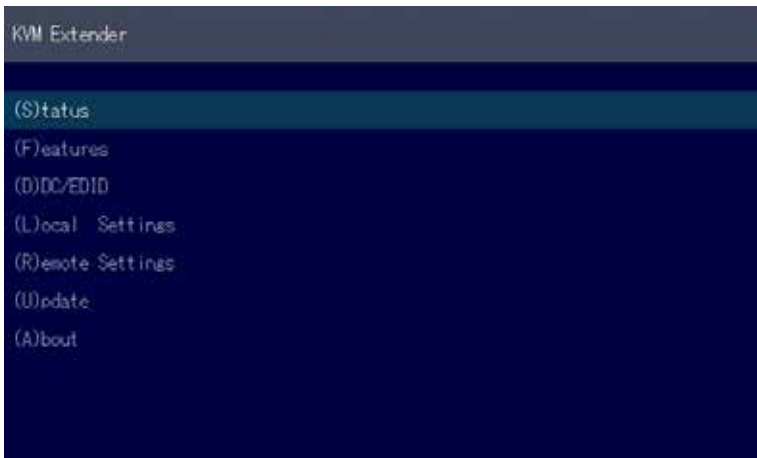

3. EXTENDER SETTINGS

3.6.1 LOCAL SETTINGS

View the local or remote Extender settings:

- Press the L button to display the Local Setting menu.

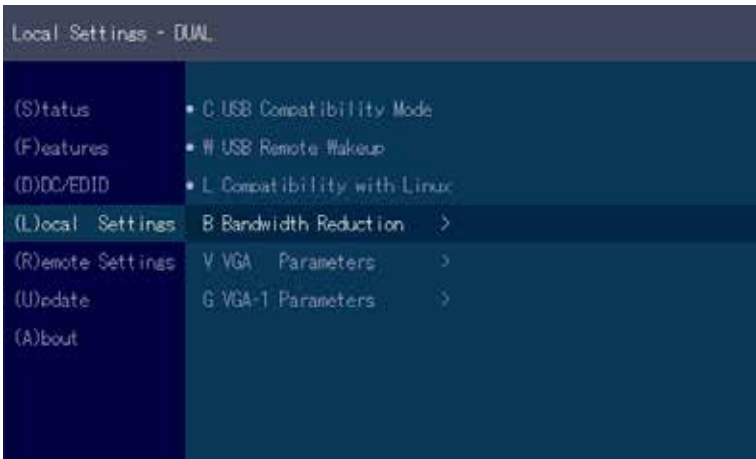

C	USB Compatibility Mode	Disabled/Enabled
W	USB Remote Wakeup	Disabled/Enabled
L	Compatibility with Linux	Disabled/Enabled
B	Bandwidth Reduction	
V	VGA Parameters	
G	VGA-1 Parameters	

3. EXTENDER SETTINGS

3.6.2 USB COMPATIBILITY MODE



Some PC's require a USB FullSpeed (USB 1.1) connection at startup. Our extenders are detected as USB HUB's - this may cause some PC's to abort the boot process. This can be avoided with the USB Compatibility Mode.

The USB compatibility mode can be enabled or disabled. To enable / disable the USB compatibility mode

1. From the Extender Settings menu, press the L key: The LOCAL SETTINGS menu appears
2. Press the U key to enable or disable the USB compatibility mode

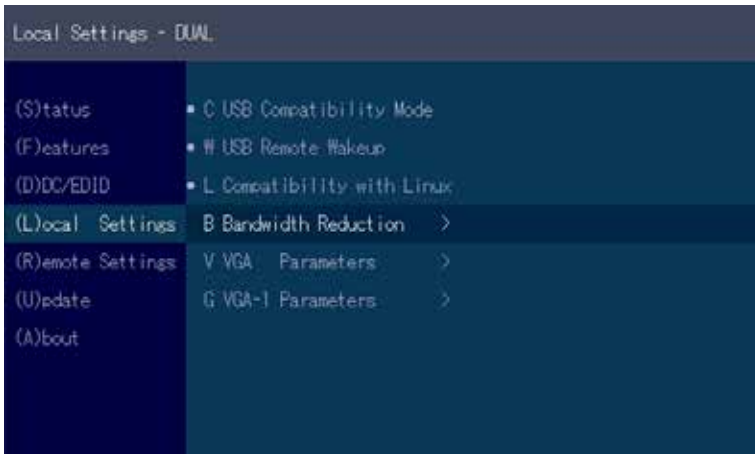

3. EXTENDER SETTINGS

3.6.3. USB REMOTE WAKE UP

The PC can be set into sleep mode and can be reactivated with any key.

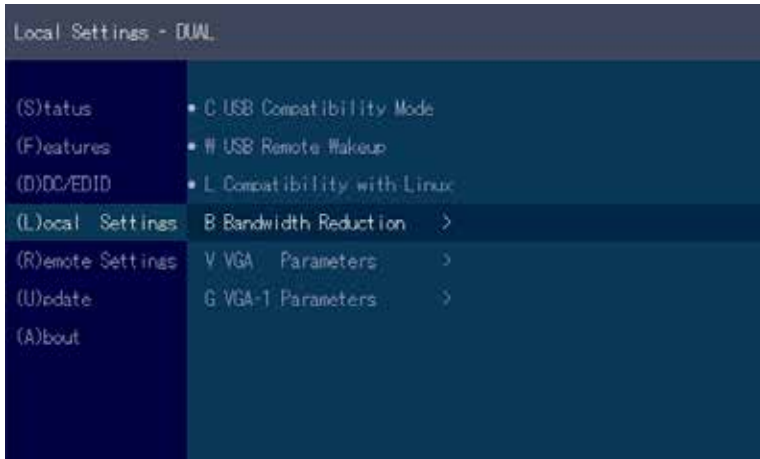

3. EXTENDER SETTINGS

3.6.4 COMPATIBILITY WITH LINUX



Older Linux (before 2010) versions may not recognize the keyboard.
In this case please activate the Linux compatibility mode

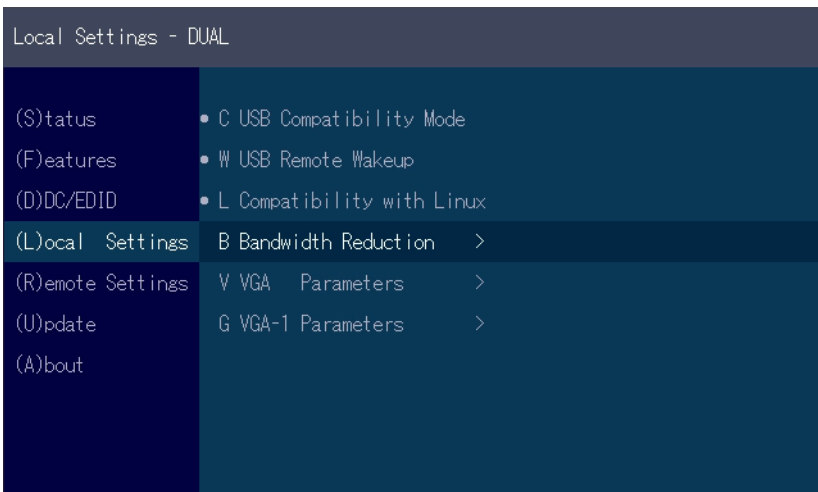

3.6.5 BANDWIDTH REDUCTION

Here the bandwidth can be reduced. The basic setting is 0!
You can change the bandwidth with +/- or u/d.

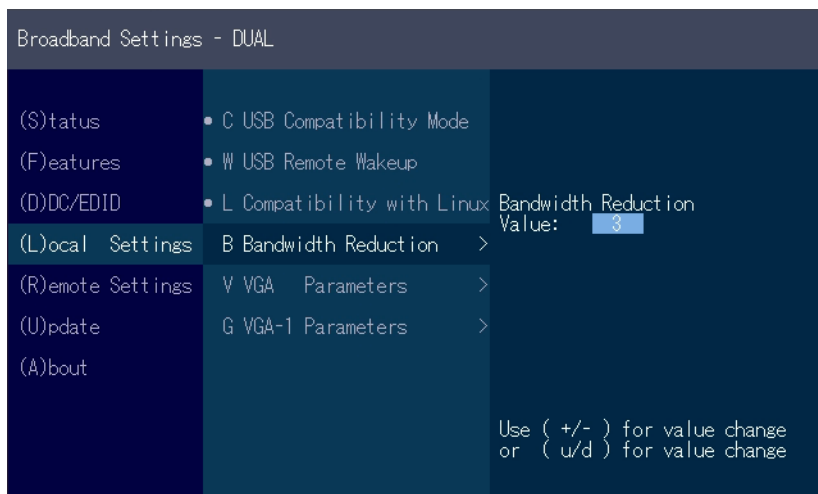

3. EXTENDER SETTINGS

3.6.6 VGA PARAMETERS

The VGA settings can be adjusted and optimized.

Optimize the VGA settings:

1. Press the **L** button in the Extender Settings menu. The Local Settings menu is displayed.
Press the **V**. The VGA menu will be displayed

- Pressing **F1** moves the display range upwards.
- Pressing **F4** moves the display range down.
- Pressing **F2** moves the display range to the left.
- Pressing **F3** moves the display area to the right.
- Pressing **F5** reduces the image (zoom out).
- Pressing **F6** enlarges the image (zoom in).

- Pressing the space bar changes the speed of the above mentioned settings.
The speed can be switched between 1 and 10.
- Pressing **M** switches the video mode between the following modes:
 - Auto - the mode is automatically detected and set by the Extender.
 - DVI - only the DVI input is recognized.
 - VGA - only the VGA input is recognized.
- Press **K** to automatically adjust and position the screen area.
- Press **I** to reset the parameters to the default values.
- Press **S** to save the settings and exit the menu.
- Press **Q** to exit without saving.

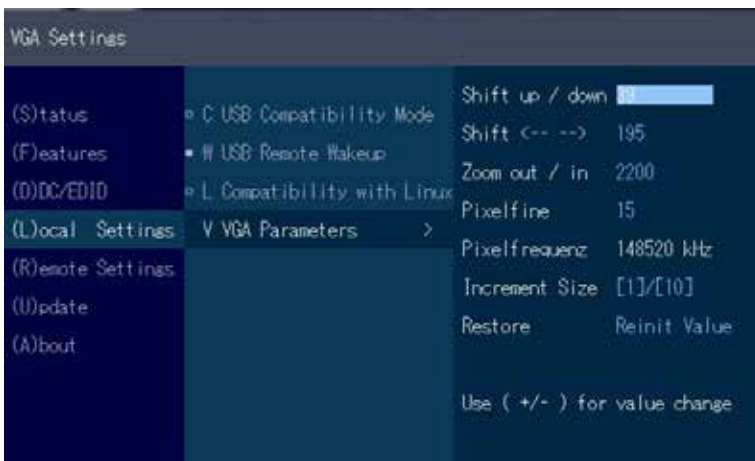

VGA Parameters

3. EXTENDER SETTINGS

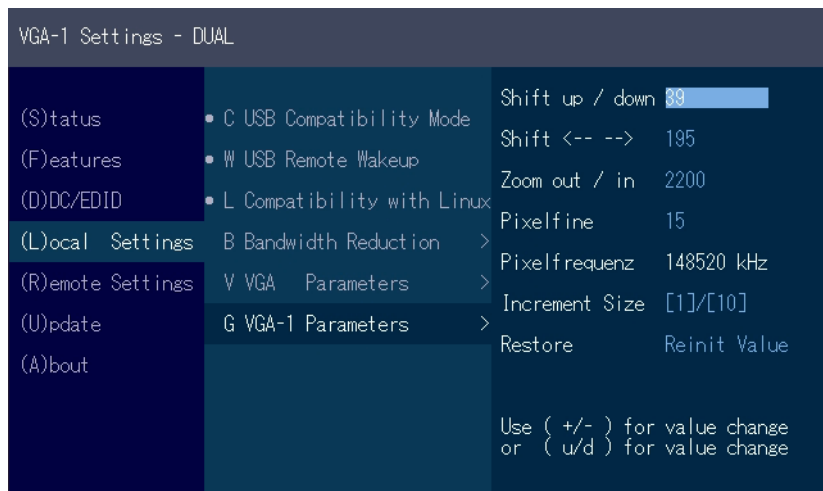

VGA-1 Parameters

3.7 REMOTE SETTINGS

- Press the **R** button to display the Remote Setting menu.

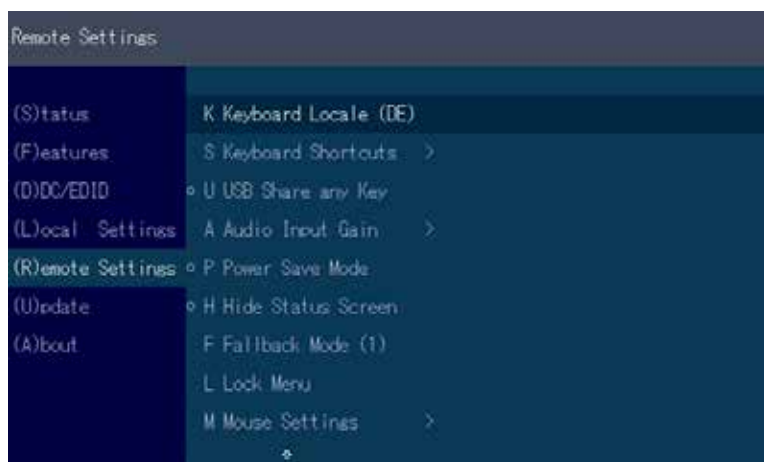

3. EXTENDER SETTINGS

3.7.1 EDITING A KEYBOARD LAYOUT

The **Keyboard Local** menu lets you switch between keyboard layouts for navigating the on screen display menu (OSD). You can choose between French (FR), English (EN) and German (DE).

Selecting a keyboard layout:

1. Press **R** in the **Extender Settings** menu- The **Remote Settings** menu appears.
2. Press the **K** key. The **Keyboard Locale** menu opens:
 - Press **E** to select English (EN)
 - Press **D** to select German (DE)
 - Press **F** to select French (FR)

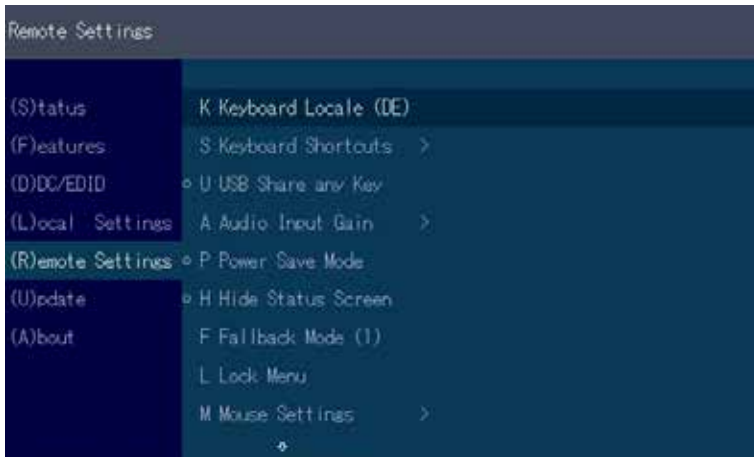

3. EXTENDER SETTINGS

3.7.2 EDITING KEYBOARD SHORTCUTS

You can change the keyboard shortcuts for common commands. You can choose your scroll speed. Edit shortcuts and change scroll speed on the Keyboard Shortcuts screen.

To edit the shortcuts:

1. From the **Extender Settings** menu, press the **R** key. The **Remote Settings** menu appears.
2. Press the **H** key. The **Keyboard Shortcuts** menu opens.
3. Use the arrows to select a command.
4. Press **E** to edit the shortcut.

To edit:

Press a single key. Edit the frequency with left and right arrows.

OR -

Press a key combination

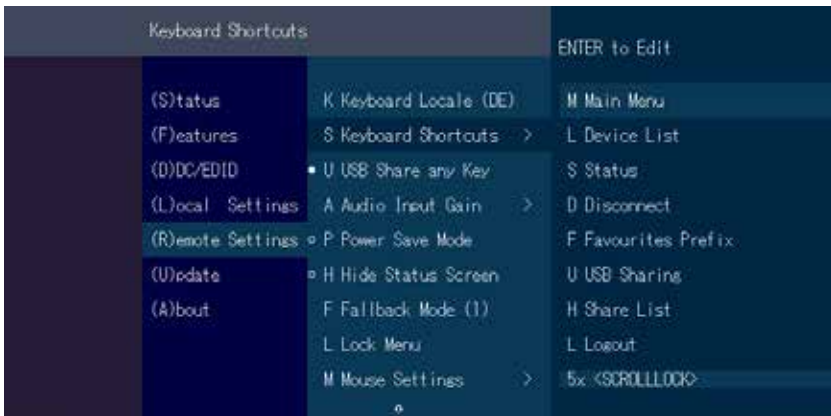

dual

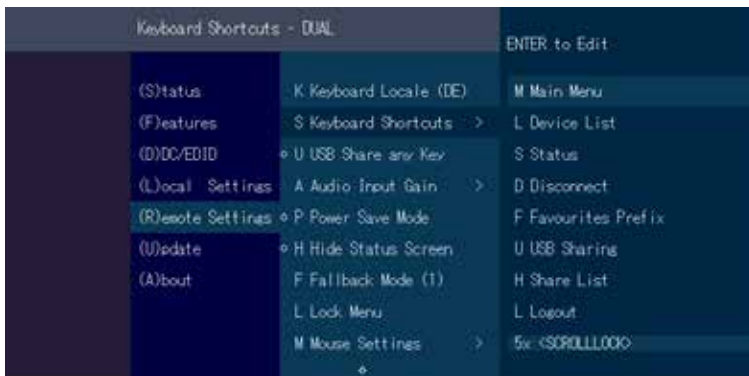

single

3. EXTENDER SETTINGS

3.7.3 SETTING THE AUDIO VOLUME

The volume of the audio input (microphone) on the remote unit can be changed. The default value is 5 but can be set to any value in between 0 and 9. At 0 the audio input on the remote unit is disabled.

Setting the volume:

1. From the **Extender Settings** menu, press the **R** key. The **Remote Settings** menu appears.
2. Press the **A** key. The **Audio Input Gain** menu appears.
Press arrow left / right to change volume
Press arrow up / down to set direction

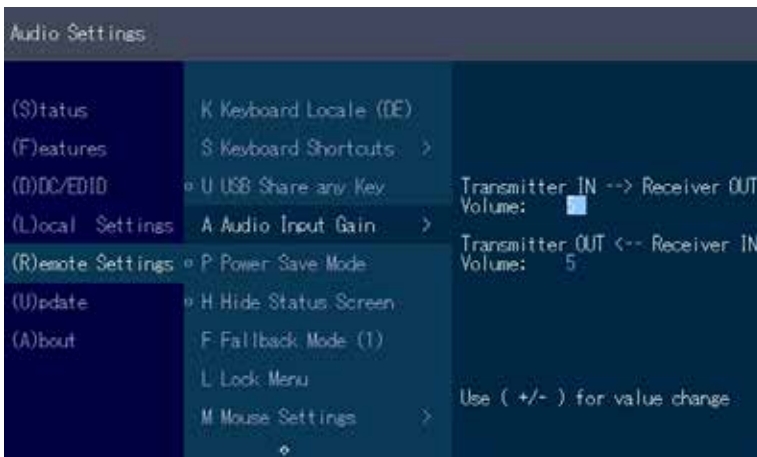

3. EXTENDER SETTINGS

3.7.4 USB SHARE ANY KEY

By pressing the button „B“ the USB Share any Key mode can be activated or deactivated.

If the USB share any key, the USB function can be taken over with any key.

If the function is deactivated, this works with the predefined hotkeys (see 3.7.2.)

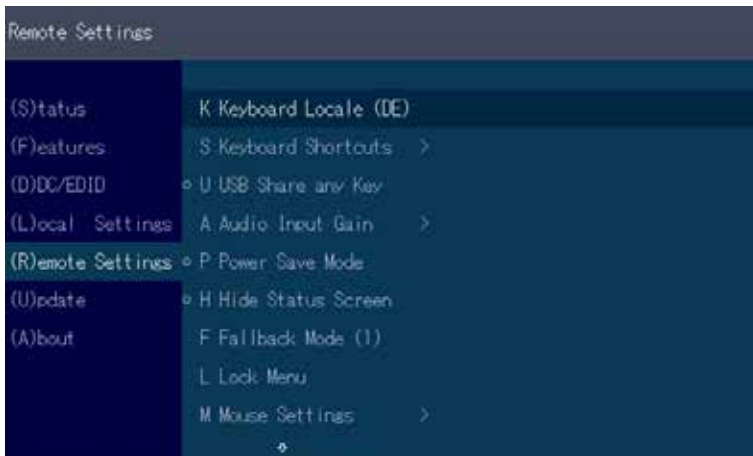

3. EXTENDER SETTINGS

3.7.5 USING THE POWER SAVING MODE

In power save mode, the Extender can switch off the video output. The power off delay can be set or deactivated as desired in the Power Save Setting menu.

If the powersave mode is active, the image output at the video outputs is turned off after the time has elapsed. To reactivate the monitor, press any key on the keyboard or connect to a partner.

Enable and disable power save mode on the remote screen. In the main menu, press G > R.

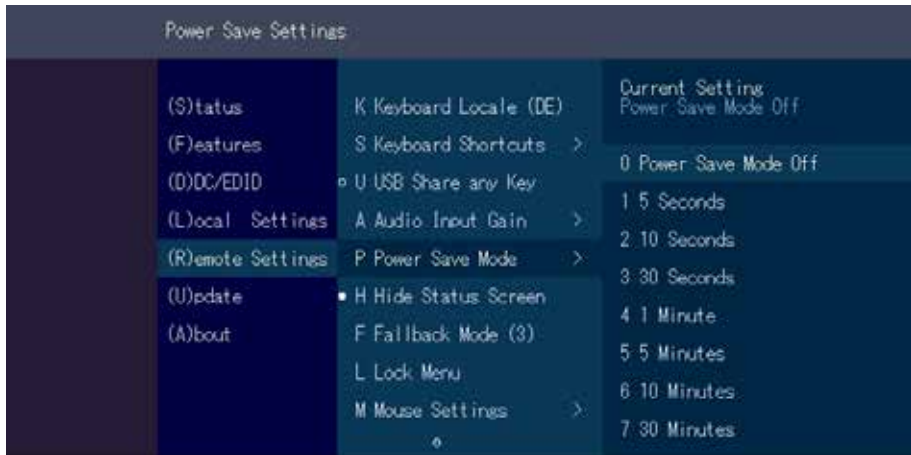

3. EXTENDER SETTINGS

3.7.6 HIDING SYSTEM STATUS MENU

Press **N** in the Remote Settings menu.

This will remove the status screen and the image remains black.

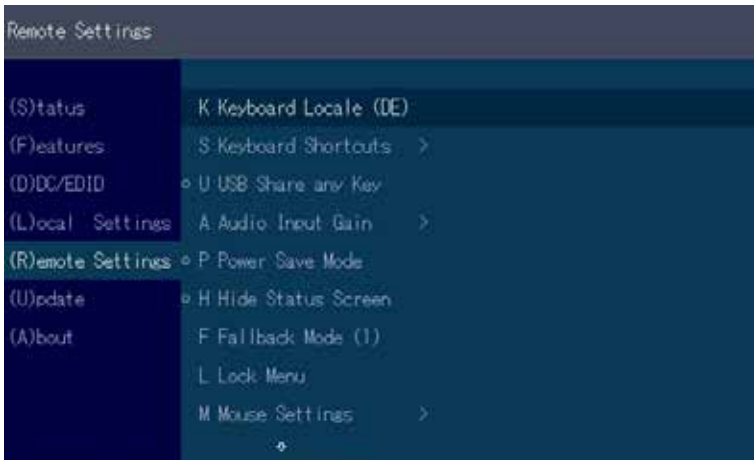

3. EXTENDER SETTINGS

3.7.7 CHANGE KEYBOARD FALLBACK MODUS

To use the OSD menu, the keyboard on the remote device must be identified.

For most keyboards, use the 0 setting.

When using USB, some mice act like a keyboard. In this case, select fallback mode 1 or 2.

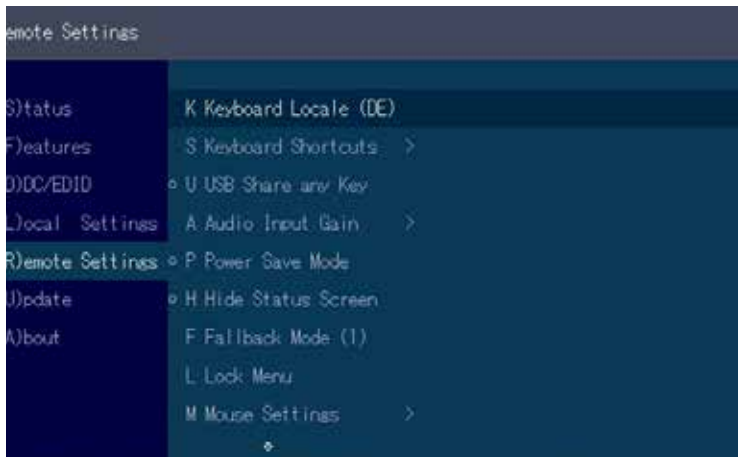

3. EXTENDER SETTINGS

3.7.8 LOCK MENU

This menu protects the OSD control and after 5 minutes the OSD can no longer be activated.

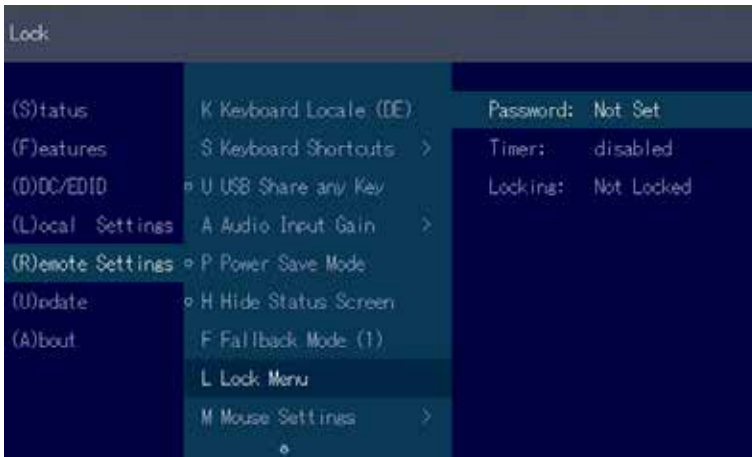

3. EXTENDER SETTINGS

3.7.9 MOUSE SPEED

Can be used in USB Emulation mode, Mouse glide & Switch and Multiview Commander. With this function the horizontal and vertical speed can be adjusted

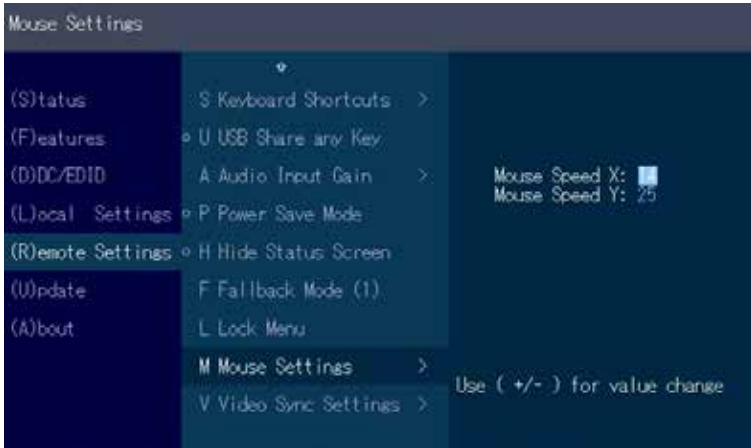

3.7.10 MONITOR SYNC STRENGTH

The frame start of the monitor is synchronized with the graphic card. Some monitors are very sensible regarding frequency changes. Therefore the changes should be done slow and the synchronization takes a bit more time. The monitor sync strength can be adjusted between 0-3.

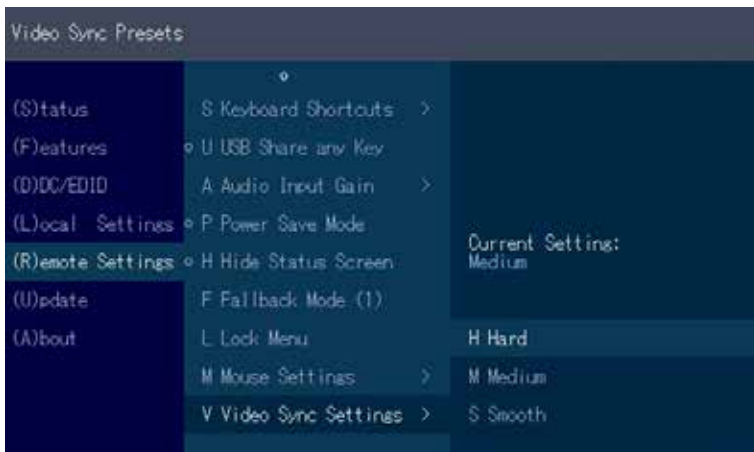

3. EXTENDER SETTINGS

Video Sync Presets		
(S)tatus	K Keyboard Locale (DE)	Current Primary: Medium
(F)eatures	S Keyboard Shortcuts >	1 Primary-Hard
(D)DC/EDID	U USB Share any Key	2 Primary-Medium
(L)ocal Settings	P Power Save Mode	3 Primary-Smooth
(R)emote Settings	H Hide Status Screen	4 Primary-Disable
(U)pdate	F Fallback Mode (1)	
(A)bout	L Lock Menu	
	M Mouse Settings >	
	V Video Sync Settings >	

single

Video Sync Presets		
(S)tatus	K Keyboard Locale (DE)	Current Primary: Medium Current Secondary: Medium
(F)eatures	S Keyboard Shortcuts >	1 Primary-Hard
(D)DC/EDID	U USB Share any Key	2 Primary-Medium
(L)ocal Settings	P Power Save Mode	3 Primary-Smooth
(R)emote Settings	H Hide Status Screen	4 Primary-Disable
(U)pdate	F Fallback Mode (1)	5 Secondary-Hard
(A)bout	L Lock Menu	6 Secondary-Medium
	M Mouse Settings >	7 Secondary-Smooth
	V Video Sync Settings >	8 Secondary-Disable

dual

3. EXTENDER SETTINGS



3.8 UPDATE

3.8.1 FIRMWARE UPDATE WITH SWITCHING MANAGER

Update management is carried out via the Switching Manager software included in the delivery see **User Manual Switching Manager 2000 chapter 10.2**

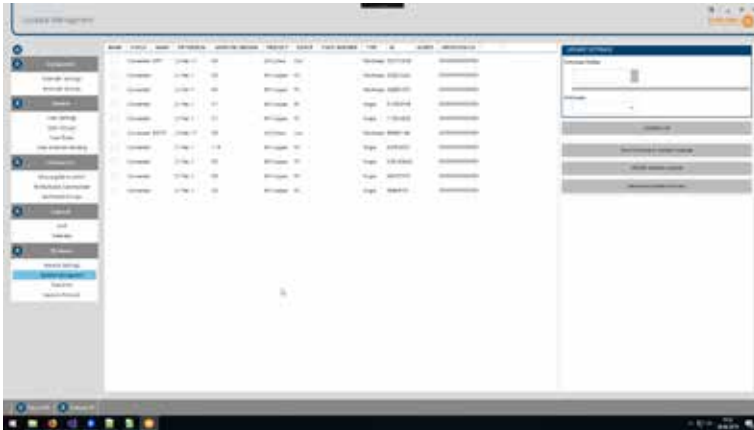

In this view, all extenders for which a firmware update is to be performed are displayed. This function displays a list of the extenders that are assigned to the Switching Manager. Updating the extenders in the system is a two-step process. In the first step the firmware is loaded into the device and in the second step the update is performed. All extenders in the system file can also be updated together. For the update, activate the Settings window and select the folder from which the firmware file is to be uploaded. The list of bitmaps is displayed under MX Firmware. Then transfer the firmware and the update will be done in two steps.

1. send the firmware to the extender.

It takes about 2 minutes until the firmware is loaded into the extender. The bar on the right in the column the main window fills blue

2. is the update.

ATTENTION Only if the bar is grey, the update is finished.

3. EXTENDER SETTINGS

3.8.2 FIRMWARE UPDATE WITH USB STICK

For the update with an USB stick the following steps are necessary

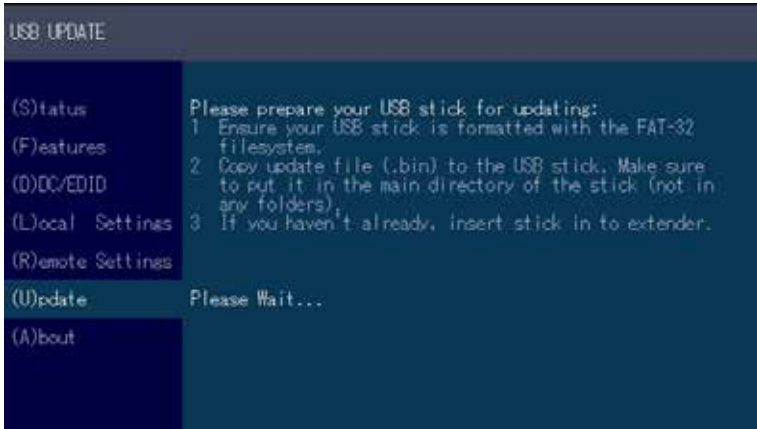

1. you receive the message that you can plug in the USB stick.
2. copy the update file (ending in .kvm) to the USB stick
3. make sure that the update file is directly on the stick and that it is not in any subdirectory
4. the USB stick must be formatted with FAT-32

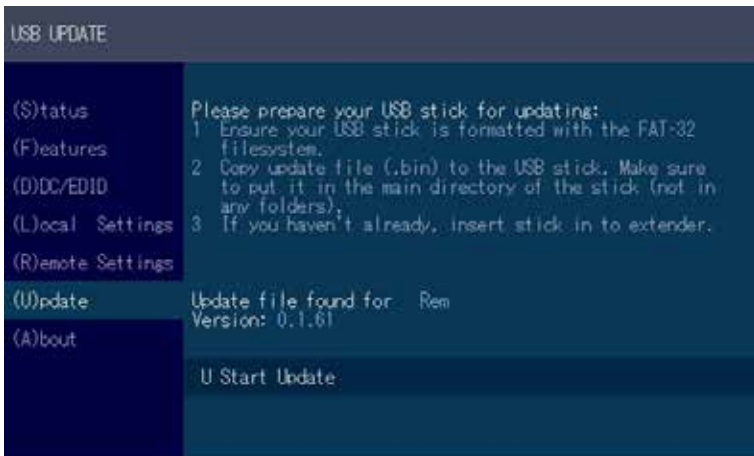

3. EXTENDER SETTINGS

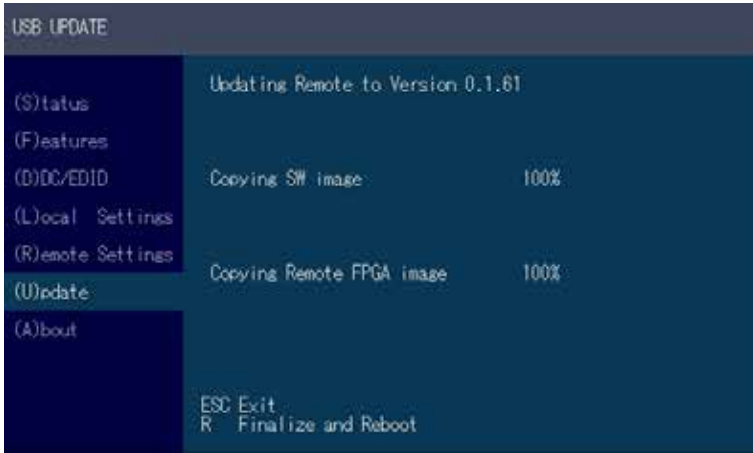

3.9 UNLOCK AN UPGRADE

1. Make sure the main menu is open.
2. Press the M key. The Options Overview menu opens. The device ID will be shown.
3. Order the unlock code from your supplier by providing them with the 9-character device ID and the serial number of your KVM-extender.
4. Press M key to enter the unlock code.
5. Enter the unlock code your supplier provided.
6. The extender will automatically restart.
7. To confirm the upgrade has been unlocked return to the Options Overview menu and check that the relevant upgrade is now displayed in green

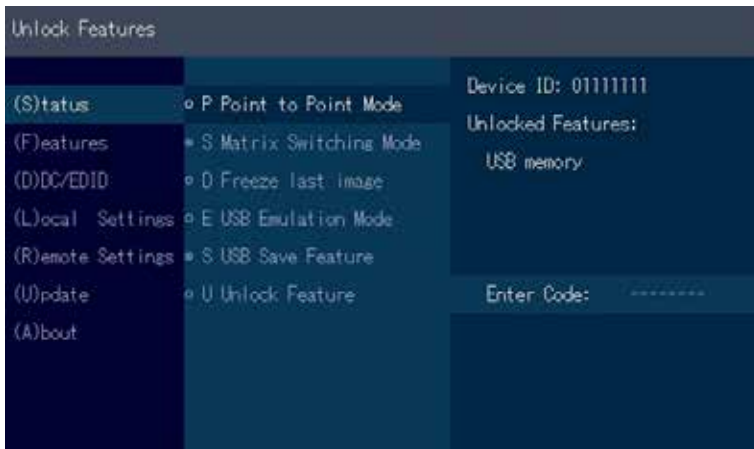

3. EXTENDER SETTINGS

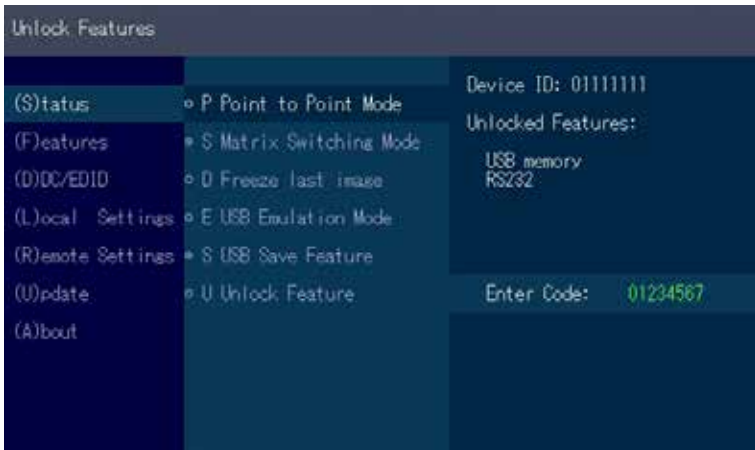
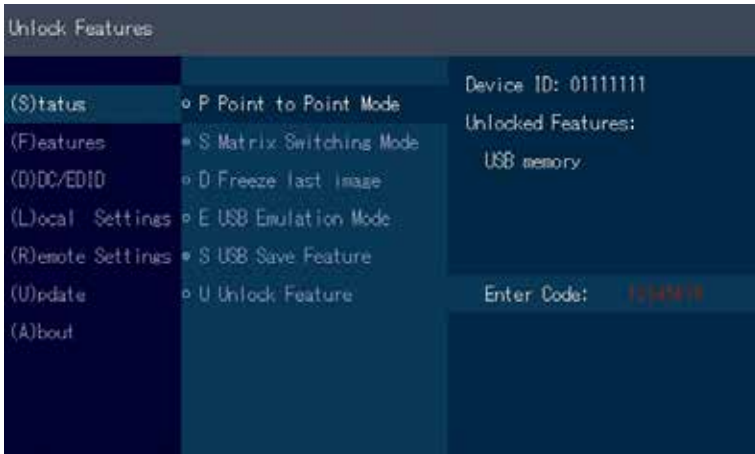
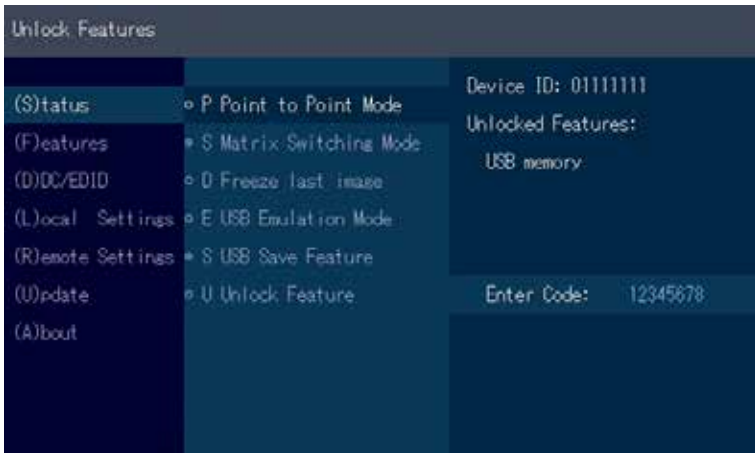

3. EXTENDER SETTINGS

3.9.1 ENABLE OR DISABLE USB MEMORY UPGRADE

The USB Memory upgrade allows the user to enable or disable the memory upgrade. When the USB Memory upgrade is enabled, USB flash storage and external storage devices can be accessed via the extender. If your extender was provided with the USB Memory upgrade you can enable and disable at any time.

1. Make sure the main menu is open.
2. Press the M key. The Options Overview menu opens. The current USB Memory status is displayed (Enabled or Disabled).
3. Press 1 to enable or 0 to disable the USB Memory upgrade.

3.9.2 ENABLE OR DISABLE SOUND UPGRADE

This upgrade enables analog sound transmission in both directions in CD quality.

For a description of how to enable or disable the sound upgrade, see in Chapter 3.9 „Unlock an upgrade.

3.9.3 ENABLE OR DISABLE VGA UPGRADE

This upgrade enables the use of VGA analog signals on the local unit.

For a description on how to enable or disable the sound upgrade, see in Chapter 3.9 “Unlock an upgrade.

3. EXTENDER SETTINGS

3.10 ABOUT THIS DEVICE

By pressing the „A“ button, or by selecting the arrow keys, you can access the info menu, where you can obtain information about hardware and software versions, as well as the activated upgrades. You can also see the current firmware version here.



single



dual

4. NETWORK SETTINGS

4. NETWORK SETTINGS AND MANAGEMENT SWITCHING SYSTEMS

All network settings, user administration and extender management are done via the included Switching Manager software and all functions are described in the Switching Manager 2000 manual. You can download the manual from our website. www.kvm-tec.com

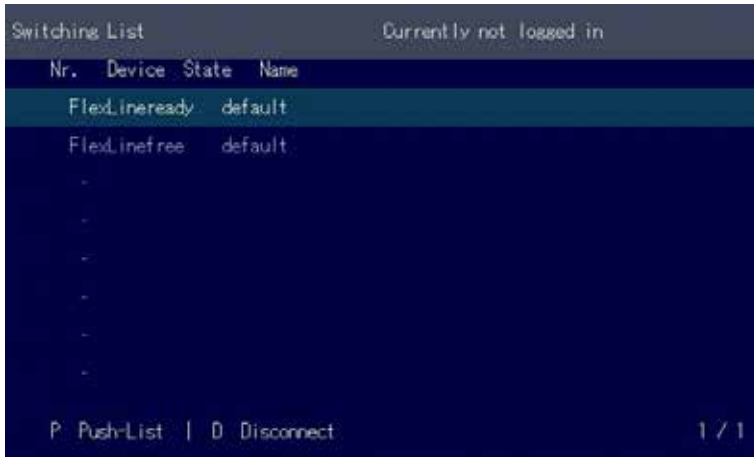

```
Switching List                               Currently not logged in
Nr. Device State Name
FlexLine ready default
FlexLine free default
-
-
-
-
-
-
P Push-List | D Disconnect                    1 / 1
```

4. NETWORK SETTINGS

4.1 DISPLAY SWITCHING LIST

Available devices that the user can connect to are displayed here.

Create shortcut:

You can create a shortcut with the following key combination „Strg+Alt+Print“

Nr.	Device	State	Name
	FlexLine ready	default	
	FlexLine free	default	
-			
-			
-			
-			
-			
-			

P Push-List | D Disconnect 1 / 1

4. NETWORK SETTINGS

4.2 PUSH / GET LIST

Display of all extenders that can be shared. The current image of the workstation can be shared with other remote units via this list

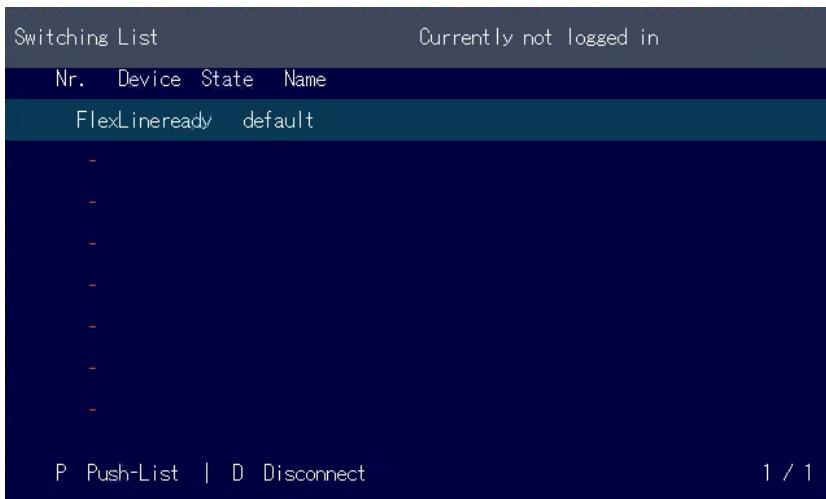
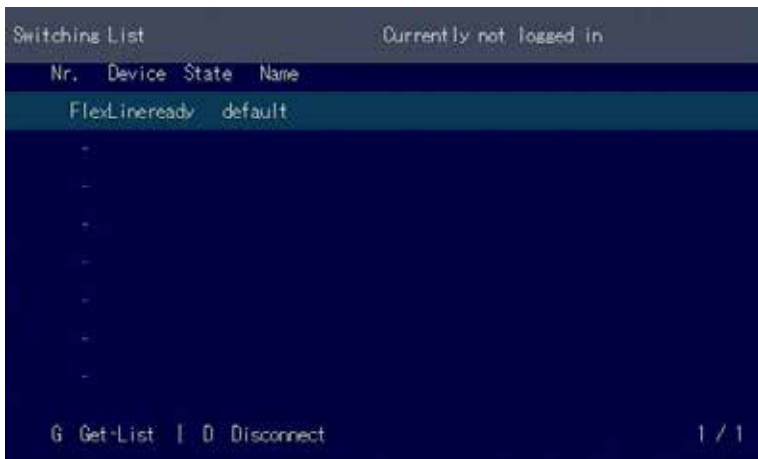

4. NETWORK SETTINGS

4.3 FAVORITE LIST

A total of 8 favourites can be defined. The connection of these 8 favourites is possible with shortcuts from 1-8

Nr.	Device	State	Name
	FlexLineready	default	
	FlexLinetree	default	
	-		
	-		
	-		
	-		
	-		
	-		

4. NETWORK SETTINGS

4.4 CONNECTING, DISCONNECTING OR SELECTING A CURRENT WORKPLACE CONNECTED DEVICES

Logging in to the local PC in the main menu, press A.

Enter your username and password.

Disconnecting from an encoder in the main menu, press D.

Enabling a direct connection

If you are not connected through a network switch, you can connect directly to an encoder with point-to-point mode.

In the main menu, press P. After logging in, the user receives his personalized lists (Devices, Favorites List).

4. NETWORK SETTINGS

4.5 SEARCHBOX-FUNCTION

In the list view you can search for the different extenders

Nr.	Device	State	Name
	FlexLine ready	default	
	FlexLine free	default	
-			
-			
-			
-			
-			
-			

In the list view you can see all available extenders. To search for specific Extenders, you must press the „TAB“ key. Now you can enter a string to search for the Extender you want to see. Press the Return key, you should now see a reduced list of Extenders.

4. NETWORK SETTINGS

4.6 IP MANAGEMENT

The KVM extenders from kvm-tec support three different addressing methods. The IP Management menu is only accessible in the active "Matrix Switching Mode" under Features.

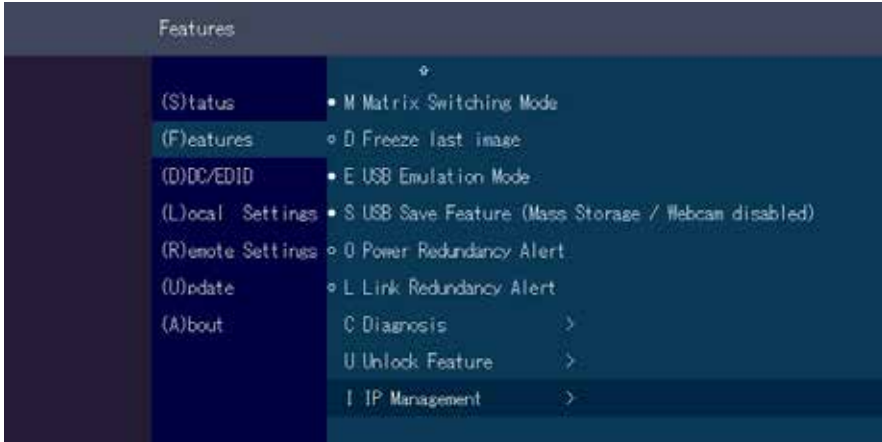

Default

In default mode, each Extender generates an IP address using the ID number to avoid number collisions in the network.

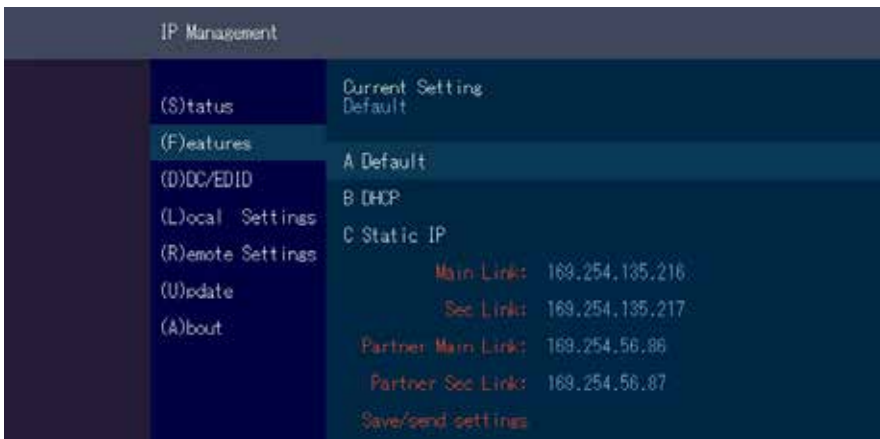

4. NETWORK SETTINGS

DHCP

The KVM extenders from kvm-tec support the DHCP protocol (Dynamic Host Configuration Protocol). This allows the assignment of network addresses by a DHCP server.

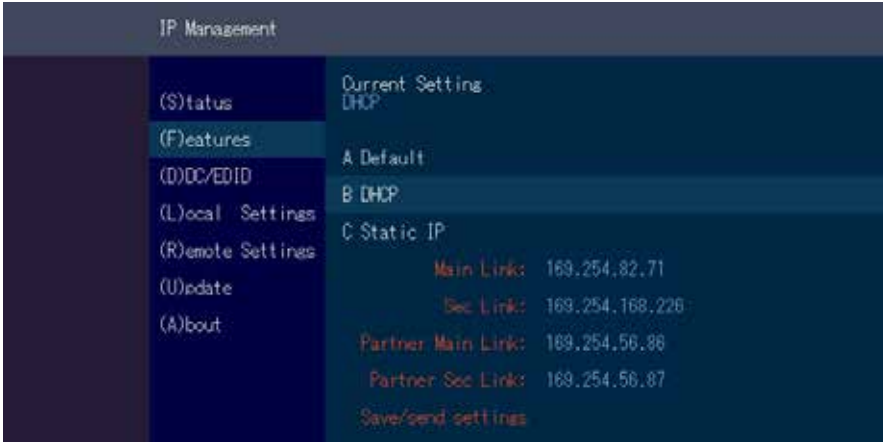

Static IP

In Static-IP mode the IP addresses can be assigned via the OSD. It is necessary to be connected to a local partner to be able to transmit IP addresses.

The blue values show the currently assigned IP addresses. With the arrow keys up / down you can overwrite the respective IP address. The addresses can be overwritten by entering a valid 12-digit number. E.g.: for the IP address 10.0.0.1 the 12-digit number 010.000.000.001 must be entered in the OSD. The separator points are added automatically.

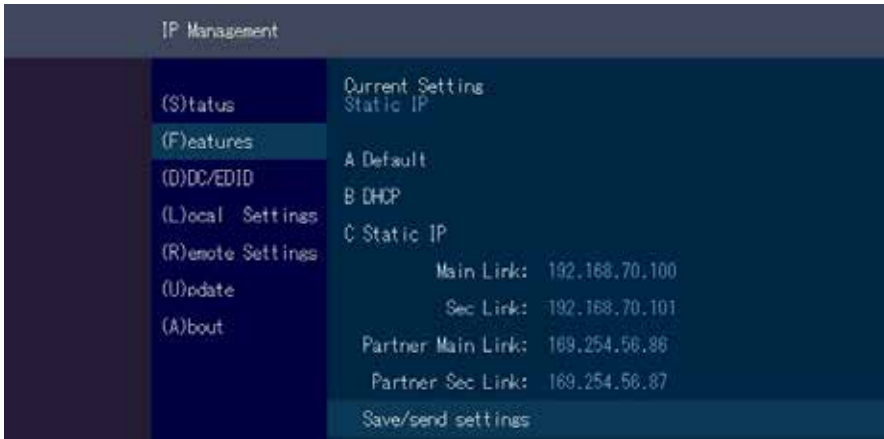

4. NETWORK SETTINGS

If all four IP addresses are overwritten, "Save/send settings" must be used to transmit the new values to the extenders.

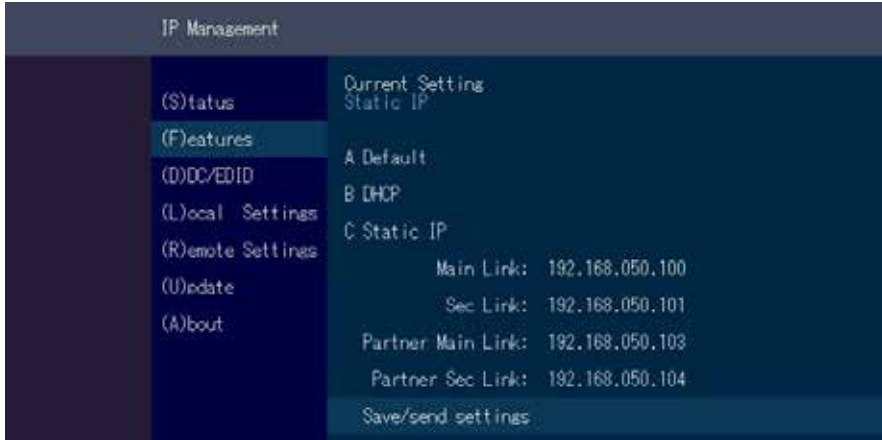

Static IP addresses can only be overwritten in Static IP mode.

5. TROUBLESHOOTING & FIRST AID

Error	Cause	Solution
LED is not lighting	<i>The devices get no power</i>	Is the power supply connected? (white box)
LED is light in red	<i>No connection between Loc and Rem</i>	Check if the RJ45/network cable is connected well. (Clicking noise when plugging in) Control local and remote , if it does not work - please send an e-mail to support@kvm-tec.com
LED is light in orange	<i>No picture on the monitor</i>	Check if the local (PC) cable is connected well. Check if the remote (monitor) cable is connected well. If everything is connected well but no function appears, reconnect power supply again. If the menu is visible, press the O key and choose the resolution of the monitor. Then press the assigned number on your keyboard.
LED is light green	<i>Screen occurs but the keyboard is not working</i>	Plug out/in USB of keyboard and wait until driver is installed (after few seconds). Check all USB connections on both sides (Local and Remote) If it is still not working, plug out/in DC once more
LED is light green	<i>No audio</i>	Establish audio connection: plug stereo-jack to the audio output of the PC (green) connection with local: IN remote: headset OUT Establish microphone connection: plug stereo-jack to the microphone input of the PC (pink) connection with local OUT. Connect the microphone to the Remote IN
LED is light green	<i>The screen flickers, has an incorrect display</i>	Install current firmware from our homepage www.kvm-tec.com/support
LED is blinking green	<i>Different firmware or USB is not compatible</i>	Please contact the kvm-tec support team via e-mail: support@kvm-tec.com or by phone: +43 2253 81912 30
LED light differently	<i>Different firmware</i>	To enter on screen menu/check firmware version: To enter the On screen menu, press the Scroll Lock key five times in quick succession. The currently installed firmware version is displayed below the menu If firmware update does not work, please send an e-mail to support@kvm-tec.com

5. TROUBLESHOOTING & FIRST AID



smart connection

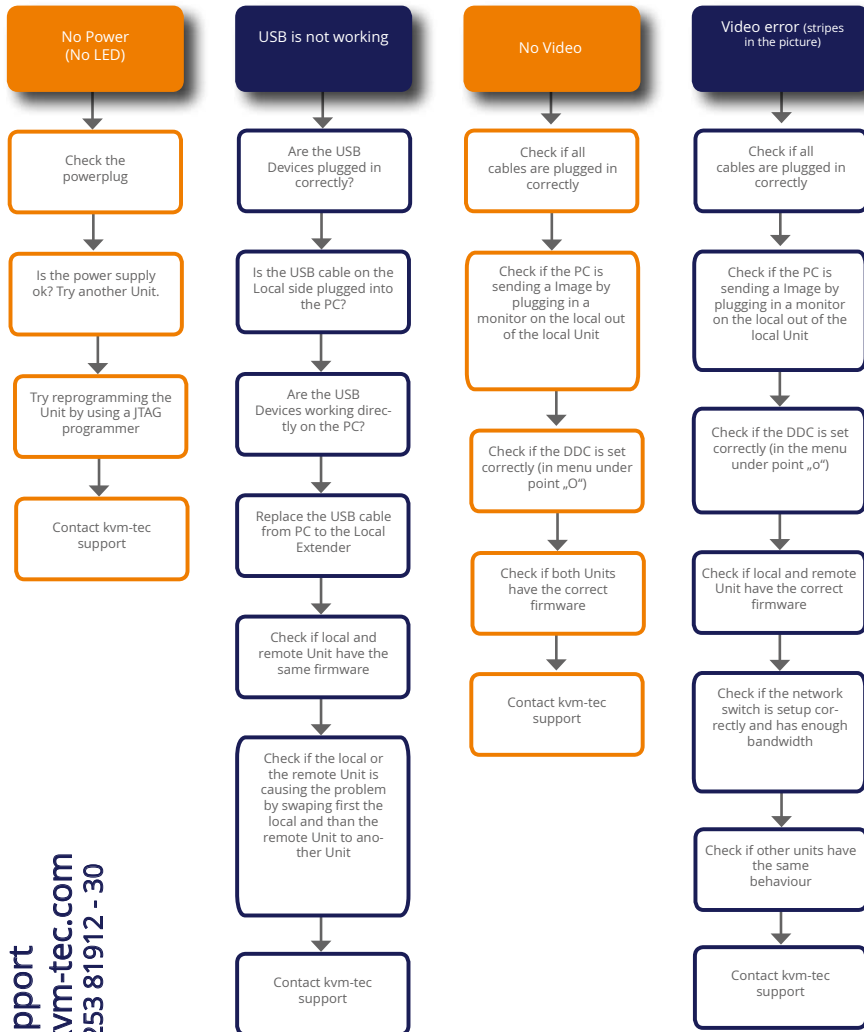

kvm-tec Support
support@kvm-tec.com
Phone: +43 2253 81912 - 30

We are here for you to answer your questions about installation?

Manual download www.kvm-tec.com

or

kvm-tec Installationchannel on our homepage personally +43 2253 81912



6.MAINTANCE & CARE

6.MAINTANCE AND CARE

6.1 EXTENDER CARE



Caution! Do not use solvent-containing cleaners. Do not use wipes, alcohols (e.g. spiritus) or chemicals as these could damage the surface.

6.2. DISPOSAL



This symbol on the product, the accessories or packaging indicates that this product must not be treated as unsorted municipal waste, but must be collected separately! Dispose of the product via a collection point for the recycling of waste electrical and electronic equipment within the EU and in other European countries that operate separate collection systems for waste electrical and electronic equipment. By disposing of the product in the proper manner, you help to avoid possible hazards for the

environment and public health that could otherwise be caused by improper treatment of waste equipment. The recycling of materials contributes to the conservation of natural resources. Therefore do not dispose of your old electrical and electronic equipment with the unsorted municipal waste.

The packaging is made of environmentally friendly materials, which may be disposed through your local recycling facilities. By disposing of the packaging and packaging waste in the proper manner, you help to avoid possible hazards for the environment and public health.

7. WARRANTY

7.1. STANDARD WARRANTY

The warranty period is 24 months from the date of purchase. The warranty expires in case of:



- External effort
- improper maintenance
- Violation of the operating instructions
- lightning damage

Please, contact us first before returning the product.

7.2 EXTENDED WARRANTY



2 years standard warranty



Art Nr KT - 9003 warranty extension to 5 years
per Set

Art Nr KT - KT - 9002 warranty extension to 5 years
per Unit

8. CABLE REQUIREMENTS

8.1 REQUIREMENTS FOR CAT5E/6/7 CABLES

A Cat5e/6/7 cable should meet the following requirements:

- The pins are connected 1:1. **Caution:** the cable pairs must be twisted to EIA/TIA- 568A (rare) or EIA/TIA-568 B (common) pairs.
- Erroneous assignments cannot be found with a simple cable tester.
- The pins for the green pair of wires are not adjacent to one other.
- The cable must at the very least meet the CAT5 specifications and be suitable for Gigabit transmission.
- The cable should meet one of the following standards: Class D ISO/IEC 11801:2002 or EN 50173-1:2002. Schema EIA/TIA-568 B.
- Only use shielded installation cable with min. cross section of 24 AWG throughout the length.
- The shield should be contiguous and connected to both ends. A shielded patch cable is allowed for connection to the device.

Schema EIA/TIA-568 B

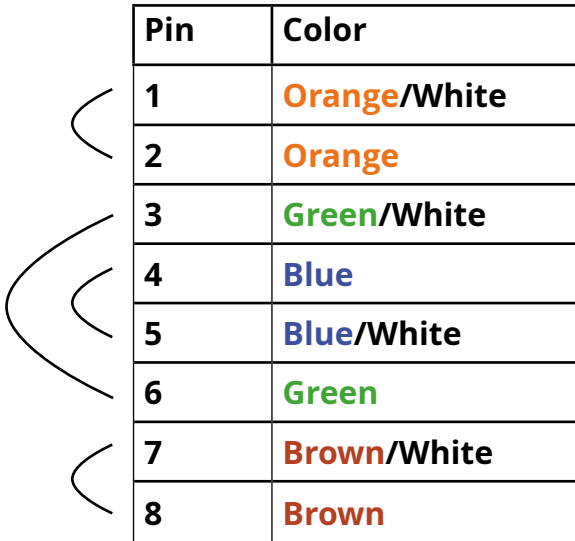

Pin	Color
1	Orange/White
2	Orange
3	Green/White
4	Blue
5	Blue/White
6	Green
7	Brown/White
8	Brown

8. CABLE REQUIREMENTS

8.2 REQUIREMENTS FIBER CABLES

8.2.1 MULTI-MODE (STANDARD)

A Multi-Mode fiber cable should meet the following requirements:

- Maximum length should be 500 m. The MV1-F includes a fiber Multimode – SFP Module which allows a transmission distance of up to 500 m.
- Dedicated fiber connection cable type Duplex Multimode 50/125 μ (OM3), LC connector

8.2.2 SINGLE-MODE (OPTIONAL)

A fiber Single-Mode – SFP Module cable should meet the following requirements:

- Up to 20 km transmission distance.
- Requires dedicated fiber connection: cable type Duplex Singlemode with LC connector

A fiber Single-Mode – SFP Module BiDi cable should meet the following requirements:

- Up to 20 km transmission distance.
- Requires dedicated fiber connection: cable type Singlemode with LC connector
Wavelength (λ) of 850 nm in multi-mode or 1310 nm TX -1550 nm RX in single-mode

9. REQUIREMENTS NETWORK-SWITCH

9. REQUIREMENTS NETWORK SWITCH

The entire switching network system requires its own separate network. For security reasons, it cannot be integrated into an existing corporate network.

The network switch must meet the following specifications:

1 Gigabit switch, with a port-to-port transfer rate of 1 Gigabit/second.

The following switches have all been tested and verified to work with all kvm-tec extenders.

Network requirements Matrix System UDP Version

The KVM-TEC Matrix Switching System communicates via IP between the individual endpoints (local/CPU or remote/CON), as well as with the KVM-TEC Switching Manager, Gateway2Go and API. Sharing of videos is realized via the IGMP function of the switch via multicast.

Each endpoint joins a multicast group, even if only one connection is established. This process is repeated cyclically so that the switch keeps the multicast group active.

One exception is the Gateway2Go, which uses unicast and communicates via UDP just like the other devices.

The following UDP ports are required for the transmission:

Port Number 53248 (0xD000) to 53260 (0xD00C)

and Port Number 50000 (0xC350)

These ports must be taken into account when configuring the firewall. For the connection via WAN a secured VPN connection is necessary.

The KVM-TEC Matrix system supports DHCP management of IP addresses, static IP addresses are possible, internal default address range and assignment of IP addresses via a DHCP server. To meet all these requirements, the use of Layer 3 switches is recommended.

10. ADDRESS & PHONE / EMAILS

10. ADDRESS & PHONE/EMAIL

If you have any questions about our products, please contact kvm-tec or your dealer.

kvm-tec electronic gmbh
Gewerbepark Mitterfeld 1A
2523 Tattendorf
Austria
Phone: 0043 (0) 2253 81 912
Fax: 0043 (0) 2253 81 912 99

11. NOTES